

DYSTRYBUTOR



TECHNICAL

GRZEGORZ TĘGOS

TECHNIKA NAPĘDU I TRANSMISJI MOCY

62-600 Koło, ul. Toruńska 212
tel. 0-63/ 27 25 478 / fax. 0-63/ 26 16 258

www.technical.pl
biuro@technical.pl

Sklep internetowy
www.sklep.technical.pl

Taśmy transportujące PU beztkaninowe z napędem zębatym



mafdel

CONTENTS



Configuration	3
Advantages	4 - 5
Positively driven conveyor belts	6 - 7
DEL/DRIVE®	8 - 11
POSITIVEBELT®	12 - 15
DEL/SYNC®	16 - 17
Accessories	18 - 19
Welding	20
Mechanically fasten joins	21
Scraper	22
Applications	23

For over 30 years French manufacturer MAFDEL has developed a **wide range of thermo-weldable conveyor belts** for industrial handling applications. Our technical teams are at your disposal to **explore your various technical challenges** and propose **customized solutions to fully meet your needs.**



CONFIGURATION

HORIZONTAL CONVEYOR



BIDIRECTIONAL CONVEYOR



FLIGHTED AND SIDEWALL CONVEYOR



SWAN-NECK CONVEYOR



TROUGHED CONVEYOR



ADVANTAGES



Our positive drive homogeneous conveyor belts combine all the **advantages of modular belts and solid conveyor belts without the hygiene issues.**

Made of polyurethane or polyester elastomer, these belts are suitable **for most handling applications** in a variety of industries, particularly in the **food-processing industry.**



OPTIMIZED OPERATION

- No risk of slippage, even in greasy and humid environments
- Belt operates without tension, reducing the stress on the conveyor's mechanical components: shafts, anti-friction bearings, roller bearing, etc.
- No need for tensioners
- Lightweight
- Silent operation
- High abrasion and tear resistance
- For belts fitted in pairs, the positive drive ensures synchronized operation
- Fully moulded teeth



OPTIMAL HYGIENE LEVEL

- Fully EC-FDA compliant
- Solid impervious and rot-proof belt
- Labour and water saving
- Resistant to all common food industry chemicals including solvents, oils, greases...
- Suitable for scraper applications



ADVANTAGES



REDUCED PRODUCT CONTAMINATION

- Reduced risk of bacterial growth
- No fabric contamination removing the risk of fraying
- No detachable parts
- Reduced contamination risk



LOWER OPERATING COSTS

- Long service life
- Quick and easy to clean without dismantling
- Significant reduction in water and detergent consumption
- Low maintenance costs



	MODULAR BELT	HOMOGENEOUS CONVEYOR BELT	POSITIVELY DRIVEN CONVEYOR BELT
Hygiene and cleanability	-	+	+
Durability and impact resistance	-	+	+
Lower consumption of water and detergents	-	+	+
No slippage	+	-	+
Belt weight	-	+	+
No belt tensioning system	+	-	+
Reduced stress on conveyor components	+	-	+
Suitable for scraper	-	+	+
Troughing application	-	+	+

CHARACTERISTICS



Our positive drive belts comply with the **most stringent international standards**, and help maintain an optimal level of hygiene to **meet the HACCP* requirements**, in the following fields:



Poultry



Meat



Fish



Cheese dairies



Fruit



Vegetables



Bakeries- Industrial
pastry-making



Ready meals



Frozen foods



*HACCP : Hazard Analysis Critical Control Point



CHARACTERISTICS

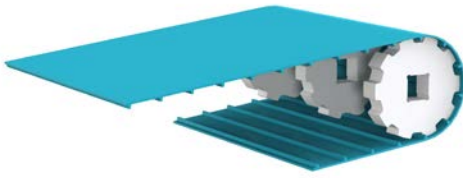

DEL/DRIVE®

Positive drive

Direct retrofit
on modular applications

Teeth over the entire width

Operation without tension

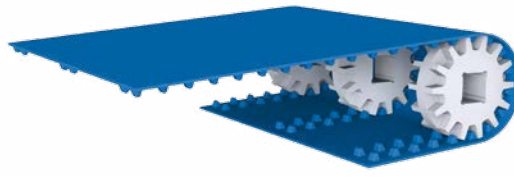

POSITIVEBELT®

Self-tracking positive drive

Perfect tracking

Double rows of teeth

Operation without tension

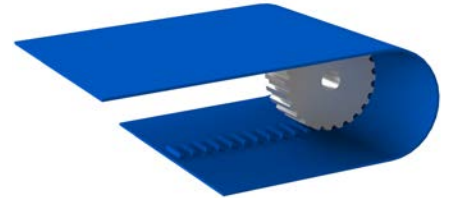

DEL/SYNC®

Fully synchronous drive

Accurate positioning

Centrally positioned teeth

Tensioned operation

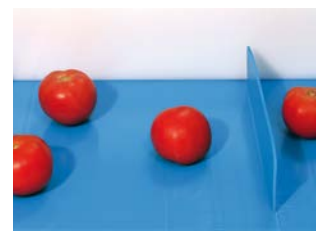

DEL/DRIVE® 50



“THE IDEAL ALTERNATIVE TO MODULAR BELTS”



	DEL/DRIVE® 50	DEL/DRIVE® 50H	DEL/DRIVE® 50EMLT
Reference	DDB50B3	DDB50B3H	DDB50B9EMLT
Material	Polyurethane	Polyester elastomer	Polyurethane
Colour	Blue	Blue	Blue
Top surface	Smooth	Smooth	Embossed
Hardness	95 ShA	55 ShD	92 ShA
Pitch* (mm)	50	50	50
Thickness (mm)	3	3	3
Overall thickness (mm)	9	9	9
Maximum width (mm)	1 850	1 850	1 200
Weights	4.8 kg/m ²	4.4 kg/m ²	4.8 kg/m ²
Min. pulley diameter (mm)	95	128	95
Min. pulley diameter - back flex (mm)	100	150	80
Temperature range	-20°C to +60°C	-20°C to +80°C	-30°C to +50°C
Traction force at 2,5% elongation for 100 mm width	65 daN	160 daN	35 daN
Friction coefficient			
On HDPE bed	0.2	0.15	0.25
On stainless steel bed	0.52	0.45	0.6

*Exact value : Contact us

DEL/DRIVE® 50



The DEL/DRIVE® positive drive belt meets the **most stringent standards of hygiene** and is **the ideal alternative to conventional modular belts**. It replaces a modular belt without any modifications. It is either driven on a sprocket or a motorized drum.

The DEL/DRIVE® belt is installed **without tension**, thereby reducing stress on the conveyor's mechanical components: shafts, anti-friction bearings, roller bearing, etc. DEL/DRIVE® can be configured with flights, sidewalls or other profiles (see page 18).

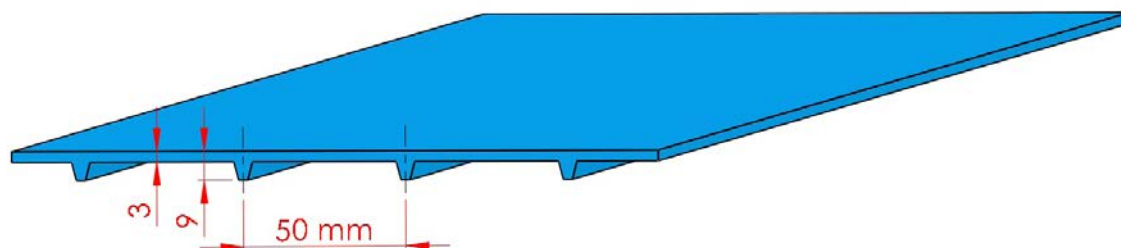

The DEL/DRIVE® comes in several versions to meet all needs:

The DEL/DRIVE® 50 belt in polyurethane is both flexible and has high tensile strength. It is the ideal solution for the conveyance of light to medium-weight loads.

The DEL/DRIVE® 50AM belt has the same characteristics as the DEL/DRIVE® 50 belt plus an infused antimicrobial treatment. DEL/DRIVE® 50AM improves food safety by inhibiting the proliferation of bacteria.

This prevents the contamination of transported products. A further benefit is the reduction of odours and cleaning cycles.

The DEL/DRIVE® 50AMEM belt has an infused antimicrobial treatment and an embossed top surface that reduces adherence of the products on the belt.

The DEL/DRIVE® 50H belt in polyester elastomer is recommended for medium to heavy loads and can be used with long centre-to-centre distances. In certain cases, its high tensile strength and low friction coefficient permits a build-up of transported products. It can withstand higher peak temperatures, depending on the load.

The DEL/DRIVE® 50EMLT belt is specially designed to operate in very low ambient temperatures. Its embossed top surface facilitates the conveyance of frozen products.

The DEL/DRIVE® 50/25 belt has 50mm drive teeth on one face, and 25mm drive teeth on the other allowing one side to drive and the other to act as low flights for increased grip.

DEL/DRIVE® 50



SPROCKETS AND IDLER WHEELS



REFERENCE	PRODUCT	MATERIAL	NUMBER OF TEETH	OUTER DIAMETER	SQUARE BORE	WIDTH (mm)
P50WUN06	Sprocket	HDPE	6	95	40	32
R50WUN06	Wheel	HDPE	-	83	40	32
P50WUN08	Sprocket	HDPE	8	128	40	32
R50WUN08	Wheel	HDPE	-	116	40	32
P50WUN10	Sprocket	HDPE	10	161	40	32
R50WUN10	Wheel	HDPE	-	149	40	32
P50WUN12	Sprocket	HDPE	12	193	40	32
R50WUN12	Wheel	HDPE	-	181	40	32

Flanged sprockets and wheels are available on request.

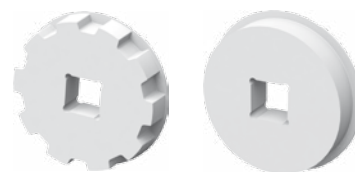

The standard sprockets we offer have a square bore for a 40x40 mm drive shaft.

They can be mounted on other shafts with special adapters.
Please enquire for any other dimensions of round or square shaft.

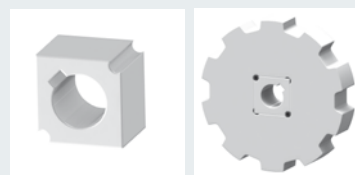

On a smooth driving drum, sprockets can be mounted on bushings or a driving drum with profiled polyurethane lagging.

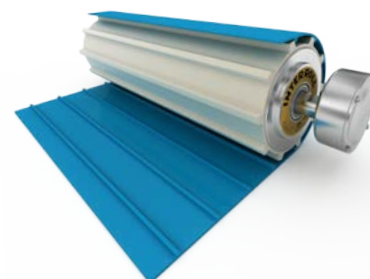
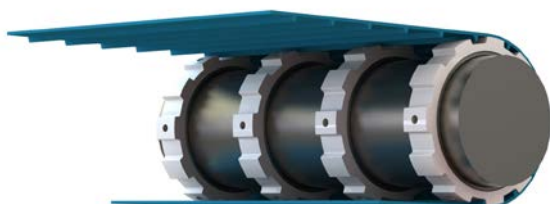

DEL/DRIVE® 25



"POSITIVE DRIVE ON SMALL PULLEY DIAMETERS"



		DEL/DRIVE® 25	
Reference		DDB25B5.3	DDB25B5.8
Material	Polyurethane		
Colour	Blue	Blue	Blue
Top surface	Smooth	Smooth	Smooth
Hardness	95 ShA	95 ShA	95 ShA
Pitch (mm)	25.3	25.3	25.3
Thickness (mm)	1.7	2	2
Overall thickness (mm)	5.3	5.8	5.8
Max. width (mm)	530	1200	1200
Weights	2.8 kg/m ²		
Min. pulley diameter (mm)	48	56.7	56.7
Min. pulley diameter - back flex (mm)	50	60	60
Temperature range	-20°C to +60°C		
Traction force at 2% elongation	25 daN for a width of 100 mm	30 daN for a width of 100 mm	30 daN for a width of 100 mm
Friction coefficient			
On HDPE bed	0.2		
On stainless steel bed	0.55		



The DEL/DRIVE® 25 belt is flexible, light with a small pitch and thickness for smaller diameter sprockets. It thus reduces the space requirements of conveyors and facilitates the transfer of transported products.



DRIVE SPROCKETS



REFERENCE	MATERIAL	NUMBER OF TEETH	OUTER DIAMETER (mm)	BORE (mm)		WIDTH (mm)
				square bore	round bore	
P25WUN06	HDPE	6	48	-	25	25
P25WUN08	HDPE	8	65	-	25	25
P25WUN10	HDPE	10	81	40	-	25
P25WUN12	HDPE	12	97.5	40	-	25



"SELF-TRACKING POSITIVE DRIVE BELT"

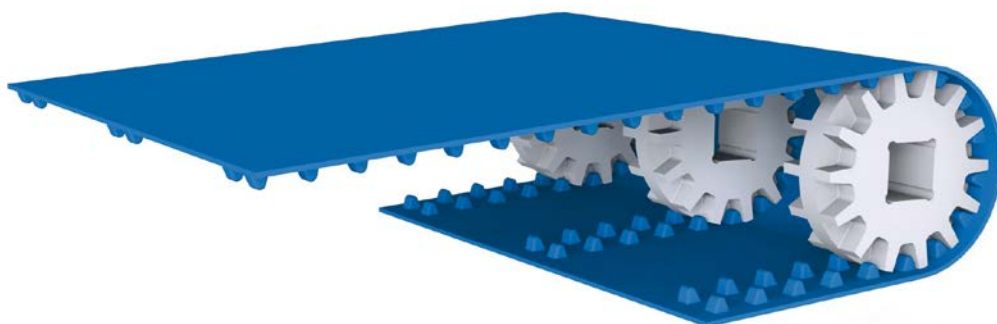

	POSITIVEBELT® P02	
Reference	PO331LB2	PO331LB2H*
Material	Polyurethane	Polyester elastomer
Colour	Blue	Blue
Top surface	Smooth	Smooth
Hardness	95 ShA	55 ShD
Pitch (mm)	31.5	30.8
Thickness (mm)	3.2	3.2
Max. width (mm)	1 000	1 000
Weights	4.8 kg/m ²	4.4 kg/m ²
Min. pulley diameter (mm)	80	120
Min. pulley diameter - back flex (mm)	80	120
Temperature range	-20°C to +75°C	-20°C to +80°C
Traction force	70 daN at 3% elongation for a width of 100 mm	165 daN at 2,5% elongation for a width of 100 mm
Friction coefficient		
On HDPE bed	0.35	0.15
On stainless steel bed	0.6	0.45

*Sprockets on demand.

POSITIVEBELT®



The positive drive thermo-weldable POSITIVEBELT® offers **exceptional guidance thanks to the dual row of teeth**.

Its **perfectly smooth top surface** makes cleaning easier and maintains an **optimal level of hygiene**. The POSITIVEBELT® can benefit of an **antimicrobial treatment**. This treatment improves food safety by inhibiting the proliferation of bacteria, and prevents the contamination of transported products. A further benefit is the reduction of odours and cleaning cycles.

The POSITIVEBELT® has **high abrasion and cut resistance**, thereby **ensuring prolonged service life**.

The belt is mounted **without tension**, reducing stress on the mechanical components. It is driven by sprockets generally mounted on a square shaft or a smooth driving drum fitted with special sprockets.

The idlershaft is fitted with disks. Wheels can be added between the sprockets and the disks.

Profiles or sidewalls can be added (see page 18).

POSITIVEBELT Polyurethane
POSITIVEBELT Polyester elastomer

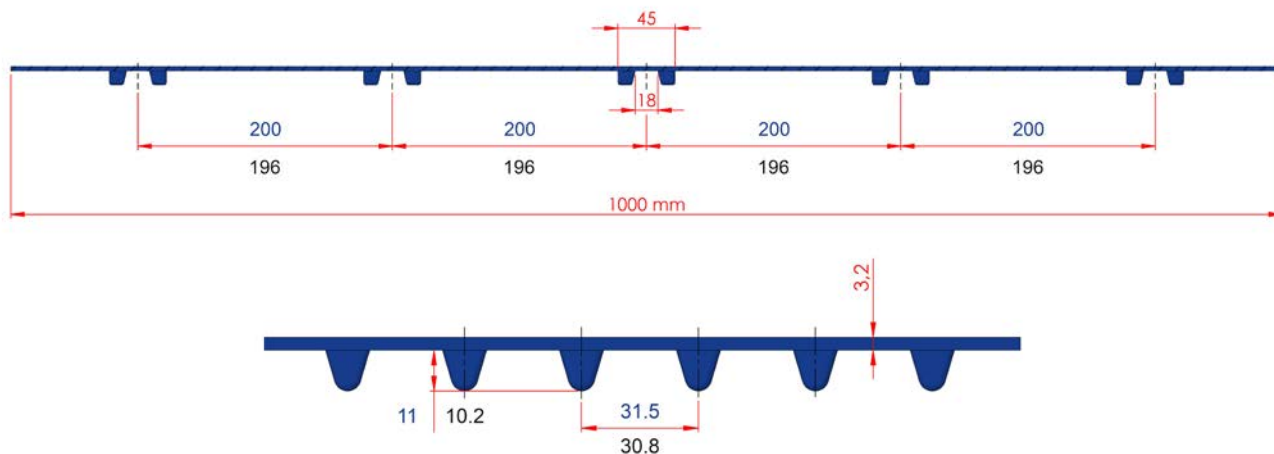



SPROCKETS



REFERENCE	NUMBER OF TEETH	OUTER DIAMETER (mm)	MATERIAL	SQUARE BORE (mm)
P31WUN10C40	10	100	HDPE	40
P31WUN12C40	12	120	HDPE	40
P31WUN14C40	14	142	HDPE	40
P31WUN16C40	16	162	HDPE	40
P31WUN20C40	20	202	HDPE	40

WHEELS



REFERENCE	EQUIVALENT NUMBER OF TEETH	OUTER DIAMETER (mm)	MATERIAL	SQUARE BORE (mm)
R31WUN10C40	10	100	HDPE	40
R31WUN12C40	12	120	HDPE	40
R31WUN14C40	14	142	HDPE	40
R31WUN16C40	16	162	HDPE	40
R31WUN20C40	20	202	HDPE	40

DISKS



REFERENCE	EQUIVALENT NUMBER OF TEETH	OUTER DIAMETER (mm)	MATERIAL	SQUARE BORE (mm)
D31WUN10C40	10	100	HDPE	40
D31WUN12C40	12	120	HDPE	40
D31WUN14C40	14	142	HDPE	40
D31WUN16C40	16	162	HDPE	40
D31WUN20C40	20	202	HDPE	40

The standard sprockets we offer have a square bore for a 40x40 mm drive shaft.

They can be mounted on other shafts with special adapters.
Please enquire for any other dimensions of round or square shaft.

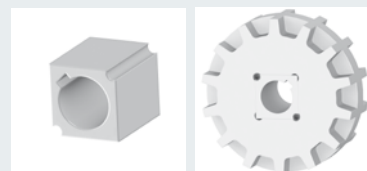

POSITIVEBELT®



Simplified conveyor design:

The POSITIVEBELT® is not only guided by self-tracking sprockets, but also be additionally guided within the sides of the conveyor. The belt tolerates transverse force, for such as lateral loading of products instance, without any risk of deviating.

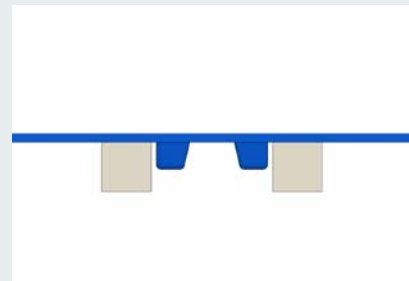

An open overhanging design of the conveyor structure combined with the absence of belt tension facilitates regular mounting and dismantling tasks.

SPROCKETS AND WHEELS FOR DRIVING DRUM

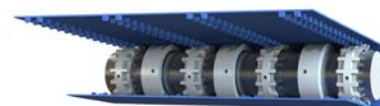

REFERENCE	PRODUCT	NUMBER OF TEETH	OUTER DIAMETER (mm)	DRUM DIAMETER (mm)	MATERIAL
P31WUN15R122	Sprocket	15	152	113	HDPE
R31WUN15R122	Wheel	-	152	113	HDPE
P31WUN18R147	Sprocket	18	182	138	HDPE
R31WUN18R147	Wheel	-	182	138	HDPE
P31WUN20R174	Sprocket	20	202	165	HDPE
R31WUN20R174	Wheel	-	202	165	HDPE

The reinforced POSITIVEBELT® P01 is a version reinforced with aramid reinforcements.

It is particularly suitable for applications such as **roller drive**, requiring **good adherence**, a **high permissible load** even with **small widths**, while at the same time **eliminating the risk of slippage**.

The absence of a tensioning system lets you **retain fixed centre-to-centre distances**, **facilitating transfers between conveyors**.

Sprockets, wheels and discs: please enquire.





"THE BELT THAT COMBINES CONVEYANCE AND SYNCHRONOUS DRIVE WITH EXTREME PRECISION"

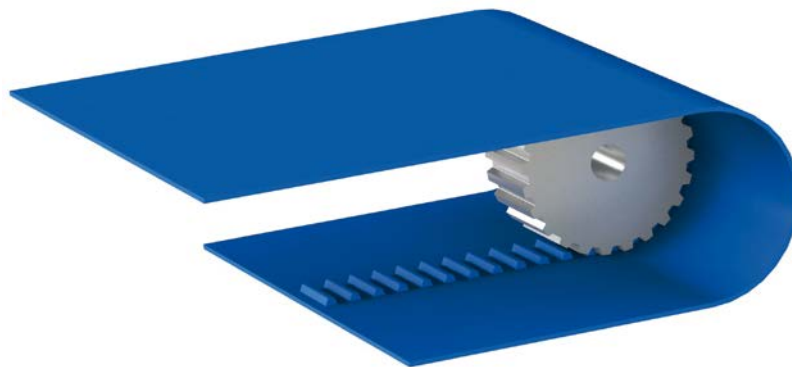

	010 SERIES			100 SERIES	200 SERIES	
Reference	AG010	AG010R	AG010R+	AG110 R	AG208 R	AG212 R
Material	Polyurethane					
Colour	Blue	Blue	Blue	Blue	Blue	Blue
Top surface	Smooth	Smooth	Smooth	Smooth	Smooth	Smooth
Hardness	80 ShA	85 ShA	85 ShA	95 ShA	95 ShA	95 ShA
Aramid cable reinforcements	NO	YES	YES	YES	YES	YES
Pitch (mm)	10	10	10	10	8	12.7
Teeth WxH (mm)	25x3	25x3	25x4.5	25x3	50x4.5 ⁽¹⁾	30x5
Thickness (mm)	1.6	1.6	1.6	2.3	3	3
Max. width (mm)	350	350	350	350	350	350
Min. pulley diameter (mm)	25	37	37	50	65	65
Temperature range	-20°C to +40°C	-20°C to +50°C	-20°C to +50°C	-20°C to +70°C	-20°C to +70°C	-20°C to +70°C
Traction force at 0,45% elongation for a width of 100mm	0.3 N/mm	50 daN	50 daN	135 daN	165 daN	165 daN

⁽¹⁾ Before 2016 : 30x4.5



The positive drive DEL/SYNC® is a **reinforced solid belt combining conveyance and synchronous drive with extreme precision** and hygiene.

It offers **excellent guidance** thanks to solid moulded teeth and **precise positioning** of the transported products.

The DEL/SYNC® is **reinforced with aramid reinforcements** that eliminate elongation.

Both the upper and lower surfaces are easy to clean and ensure **optimal hygiene**.

DEL/SYNC® also works with **small pulley diameters**.

Products in the DEL/SYNC® range offer a belt tailored **to different applications**. Consideration should be given to the need for adherence, pulley diameter, loads conveyed, length of conveyor...

A molded studded surface is available on request.

Synchronous shaped profiles can be fitted to the belt to ensure accurate indexing of the conveyed products.

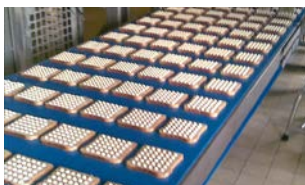
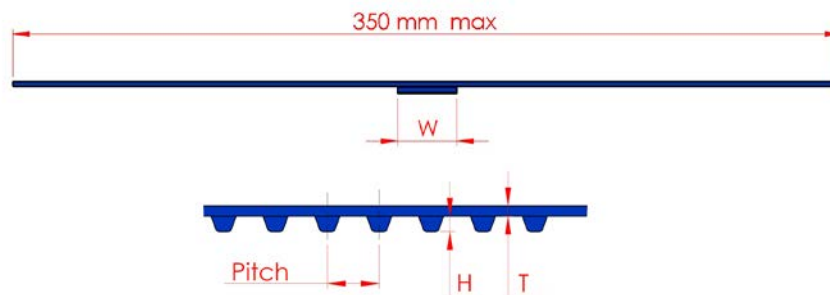

SPROCKETS

REFERENCE	COLOUR	MATERIAL	NUMBER OF TEETH	WIDTH (mm)	PITCH (mm)	OUTER Ø (mm)	Ø OF ROUND SHAFT (mm)	DEL/SYNC® SERIES
PA10BUN12R16	Blue	HDPE	12	33	10	37	16	010
PA10BUN24R25	Blue	HDPE	24	33	10	74.5	25	010 and 100
PA10BUN36R25	Blue	HDPE	36	33	10	113	25	010 and 100
PA13WUN24R25	White	HDPE	24	38	12.7	94.6	25	200 (except AG208R)
PA13WUN36R25	White	HDPE	36	38	12.7	143.1	25	200 (except AG208R)

Stainless steel sprockets on request.

The minimum pulley diameters are given for minimum temperatures of 15°C.
Please enquire for any other temperature.

ACCESSORIES



PROFILES

- 2 types of profile: rounded and flat.
- The rounded base of the profiles makes belt cleaning easier and avoids bacterial development.
- Profiles can be high-frequency welded.*
- Flight supports can be used to reinforce the profiles for heavy loads.

* Except on the DEL/DRIVE® 50H belt and POSITIVEBELT® polyester, on which the profiles are hot fillet-welded.

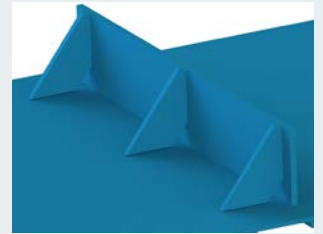

Flight supports

FLAT PROFILES



T: THICKNESS (mm)	H: HEIGHT (mm)	MAX. WIDTH (mm)	MIN. PITCH (mm)
2	5 to 130	1050	Conveyor belt's pitch
3	5 to 130	1050	
4	5 to 130	1050	
5	5 to 130	1050	

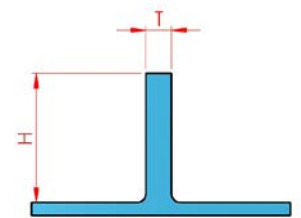

Please enquire for other thicknesses.
DEL/SYNC®: Consult us.

ROUNDED PROFILES



T: THICKNESS (mm)	H: HEIGHT (mm)	MAX. WIDTH (mm)	MIN. PITCH* (mm)
6	10	1050	50
8	13	1050	50
9	14	1050	50
12	18	1050	50

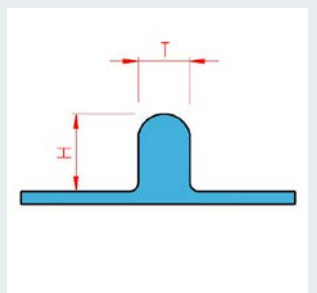

*POSITIVEBELT® and DEL/SYNC®: Consult us.

SIDEWALLS

- For better containment of loose products.
- 20 to 80 mm high.
- Lateral trapezoid-shaped guides can be welded.
- The belt pulley diameter should be at least 2.5 times bigger than the height of the sidewalls.





ACCESSORIES

TROUGH CONFIGURATION

The flexibility and tension-free operation of the conveyor DEL/DRIVE® and POSITIVEBELT® belts allow special configurations that are not feasible with modular belts, such as trough configuration.



PERFORATIONS

Perforated belts facilitate drainage of transported products. Material can be perforated on request to varying diameters.

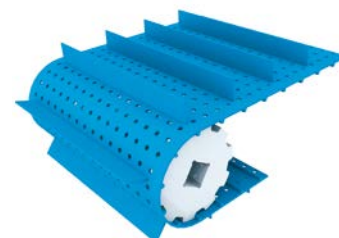

DRIVING DRUM

The driving drum on DEL/DRIVE® or POSITIVEBELT® belts reduces the footprint of conveyors and makes cleaning easier.

Solution 1: Smooth drum fitted with HDPE sprockets on stainless steel bushing (DEL/DRIVE® and POSITIVEBELT®).

Solution 2: Drum with profiled lagging in polyurethane (DEL/DRIVE®).

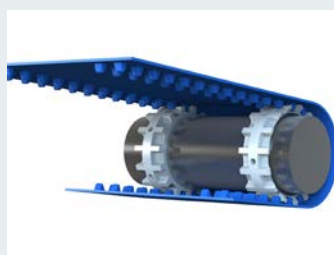

Solution 1

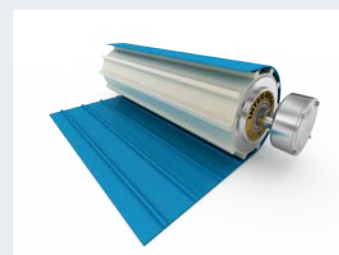

Solution 2

RETAINING CLIP

The retaining clip locks the sprockets, wheels and disks laterally on a square 40x40 mm shaft.

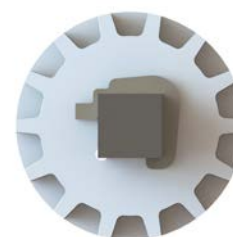

JOINING METHODS



BUTT WELDING

With sets of plates adapted for the tables, the welding tools for thermoweldable homogeneous belts can join DEL/DRIVE® 50, DEL/DRIVE® 25 and POSITIVEBELT® end to end while at the same time respecting the spacing.

Easy to handle, easy and quick to joint in the workshop and on site.



REFERENCE	MAX. WIDTH (mm)	WATTAGE (WATT)	VOLTAGE (V)
KITSOUDURED400	400	615	220
KITSOUDURED650	650	900	220
KITSOUDURED1100	1100	1450	220

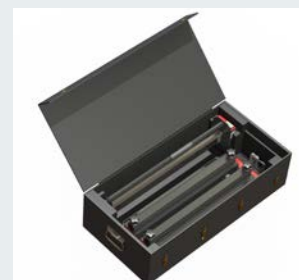

The welding kit comprises:

- A heater bar
- A welding table
- Instructions
- Accessories
- A plastic case on caster wheels

REFERENCE	MAX. WIDTH (mm)	PRODUCT	VISUAL
PLAQMD400-DD25	400	DEL/DRIVE® 25	
PLAQMD650-DD25	650		
PLAQMD1100-DD25	1100		
PLAQMD400-DD50	400	DEL/DRIVE® 50	
PLAQMD650-DD50	650		
PLAQMD1100-DD50	1100		
PLAQMD400-PO1	400	POSITIVEBELT® PO1	
PLAQMD400-PO	400	POSITIVEBELT® PO2	
PLAQMD650-PO	650		
PLAQMD1100-PO	1100		

PRESS JOINTING

Serrated jointing of the DEL/SYNC®.
Cut with special tooling.
Compatible 5-bar press – Heating length 180 mm.



HOT AIR WELDING

Butt welding possible with welding seam.
Hot air welding also allows welding of profiles and belt repairs in situ in the event of snags.

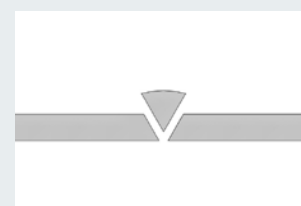



MECHANICALLY FASTEN JOINS

The DEL/DRIVE® 50 and POSITIVEBELT® conveyor belts can be jointed with mechanically fasten joins in case of frequent mounting/dismantling or repairs.

The clips facilitate removal of the belt by removing the spindle between the 2 ends for quick dismantling and cleaning of the belt and conveyor.

STAINLESS STEEL CLIPS

- Removable joint comprising 2 half-clips with stainless steel spindle.
- For belts 1.5 mm to 5 mm thick.
- Suitable for all widths.
- Using normal mechanical fastening technics

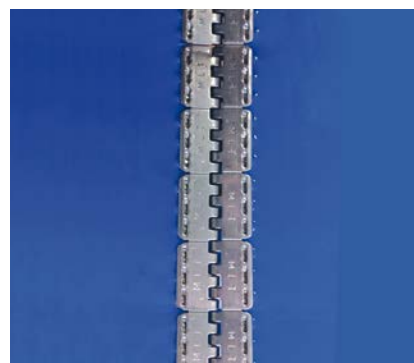

PLASTIC CLIPS

- Suitable for all homogeneous (polyurethane or polyester) belts.
- Particularly suitable in metal detecting applications.
- Up to 1100 mm wide.
- Recommended for pulley diameter higher than 120 mm.



SCRAPER



The DEL/CLEAN scraper efficiently cleans the belt, ensuring permanent cleanliness of conveyor belts and avoids:

- clogging up the conveyor
- staining conveyed materials
- loss of materials

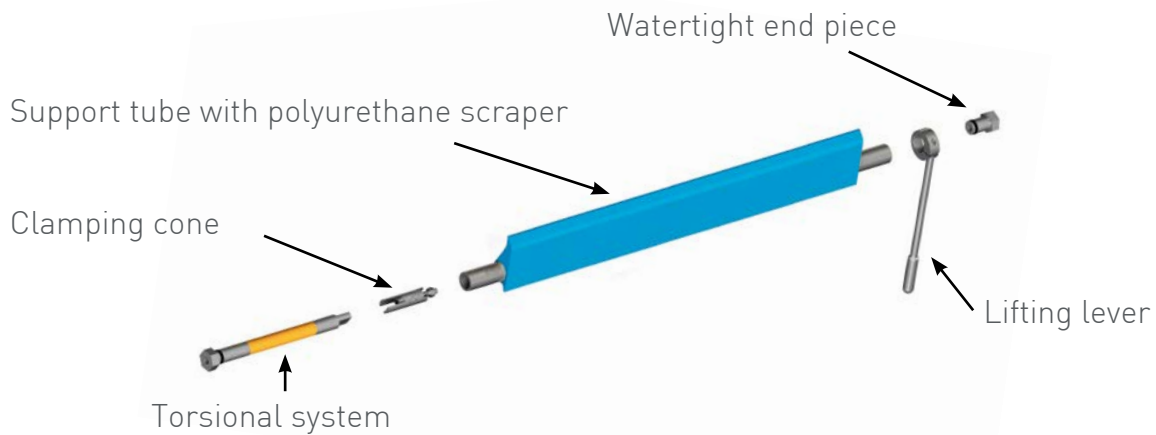

The DEL/CLEAN scraper offers many benefits:

- Small footprint
- No lateral misalignment
- Easy and quick to mount
- Can be adapted to existing or new installations
- Fits all types of conveyor belts
- Easy to clean
- Easier maintenance
- High resistance to hydrolysis: Ether base
- High resistance to abrasion: Ester base



The position of the scraper may vary depending on the need of recover the product.

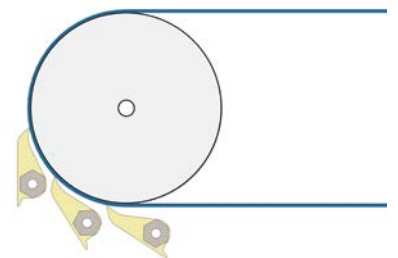

SCRAPER REFERENCE	TUBE	SCRAPER			TORSIONAL SYSTEM REFERENCE	
	Ø (MM)	Height (mm)	Width (mm)	Colour	Single	Reinforced
NT70-22-W	22	70	300 to 1100	White	ST22-S	ST22-R
NT70-22-B				Blue		
NT100-27-W	27	100	400 to 1500	White	ST27-S	ST27-R
NT100-27-B				Blue		

APPLICATIONS

