

**TECHNICAL**

GRZEGORZ TĘGOS

[www.technical.pl](http://www.technical.pl)

Krażniki gładkie - rolki gładkie do podpierania taśm transportujących w transporterach taśmowych powierzchniowych

## KRAŻNIK GŁADKI

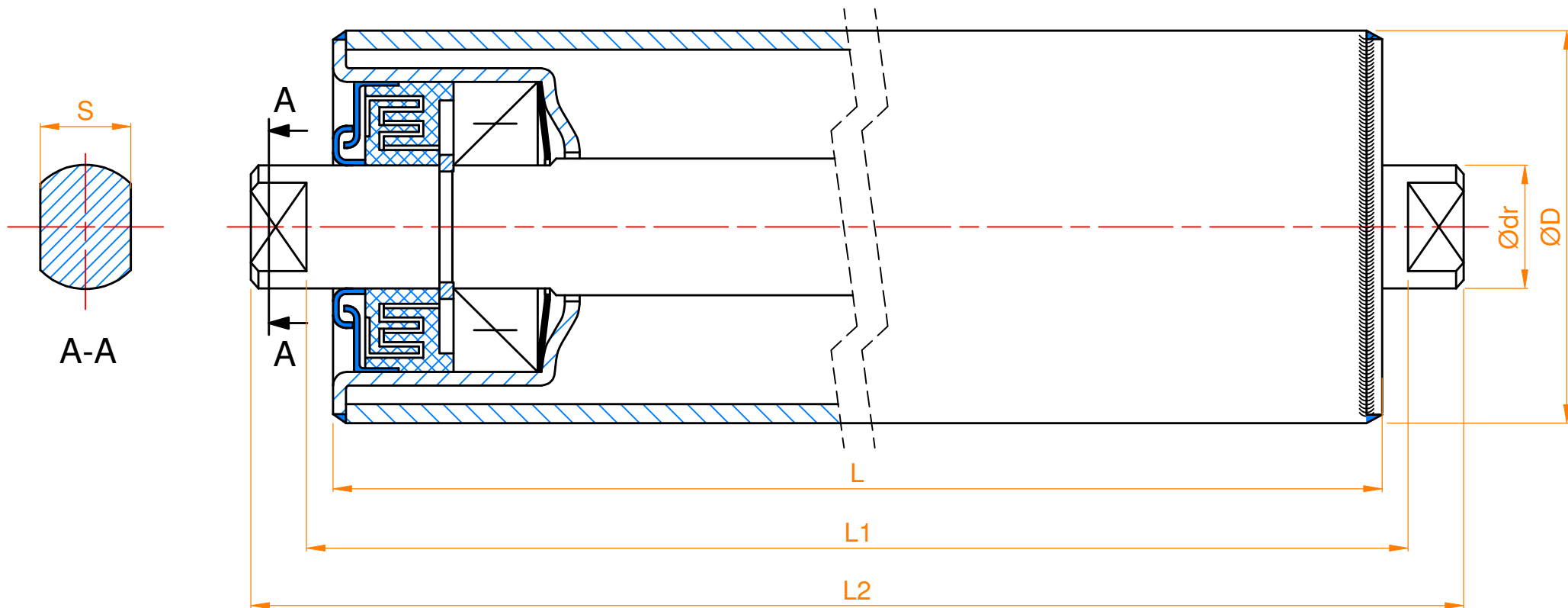

# KRAŻNIKI - KOŃCÓWKI OSI

**TYP 1**

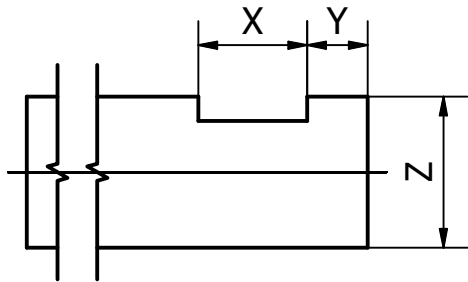
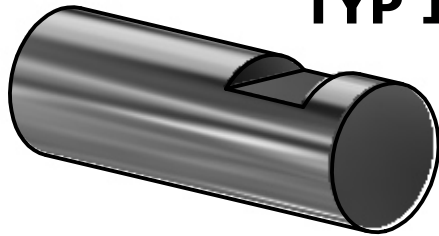

**TYP 2**

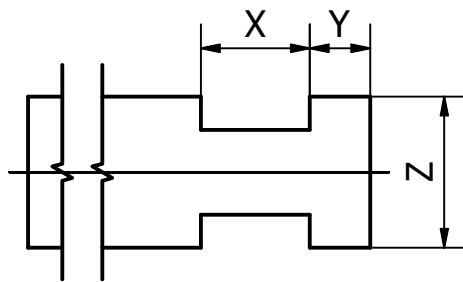
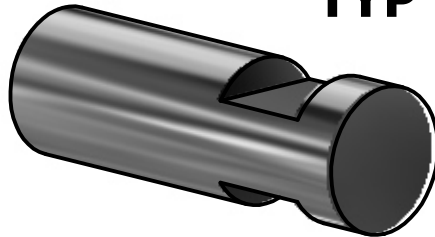

**TYP 3**

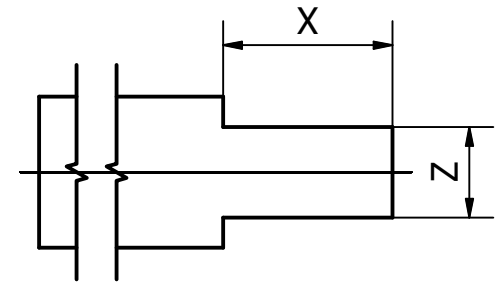
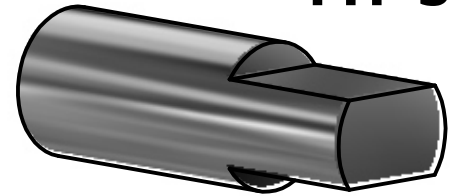

**TYP 4**

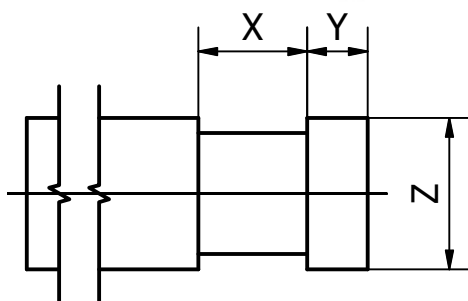
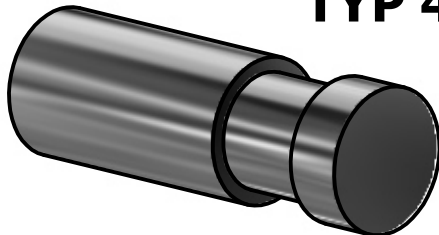

**TYP 5**

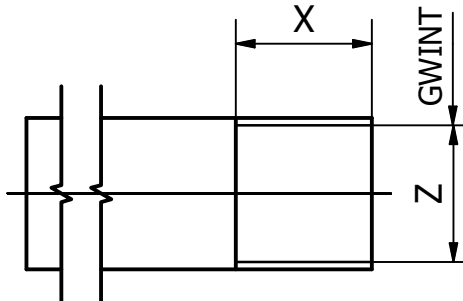
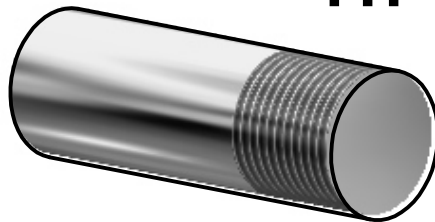

**TYP 6**

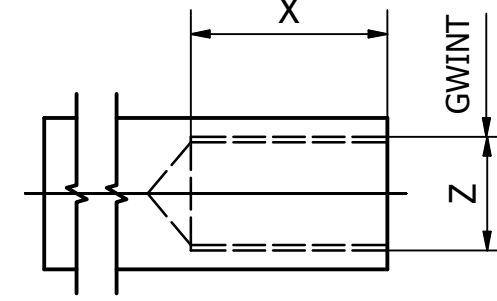
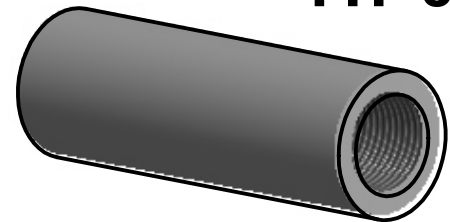

# KRAŻNIKI - KOŃCÓWKI OSI

**TYP 7**

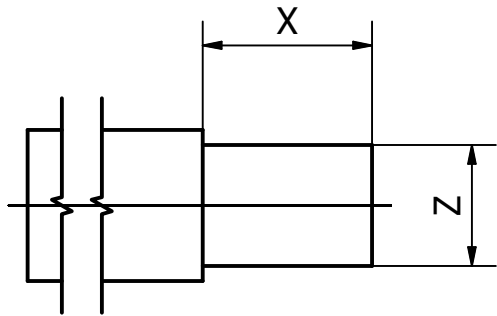
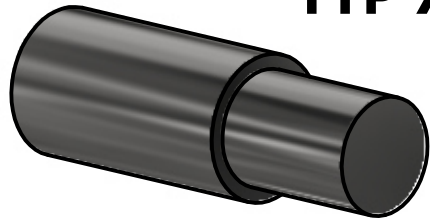

**TYP 8**

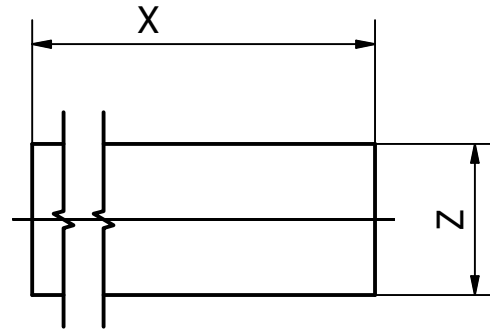

**TYP 9**

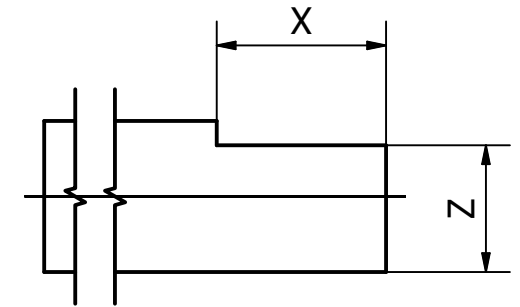
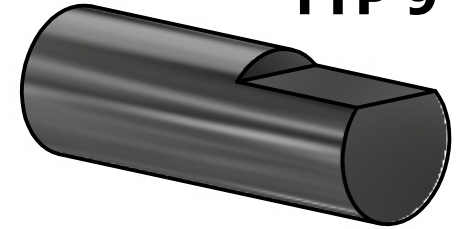

**TYP 10**

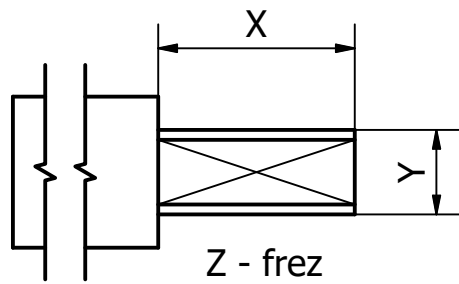
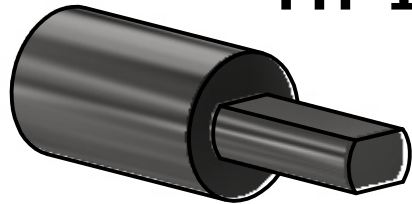

**TYP 11**

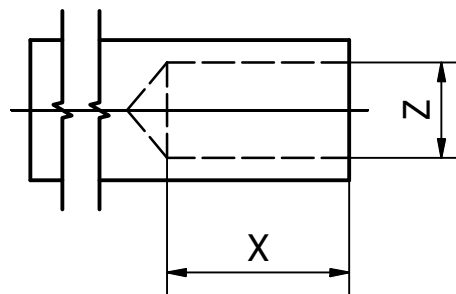
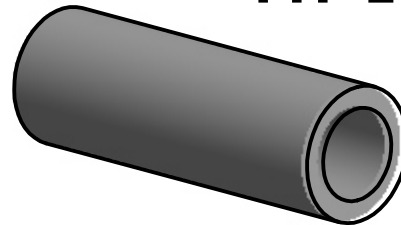

**TYP 12**

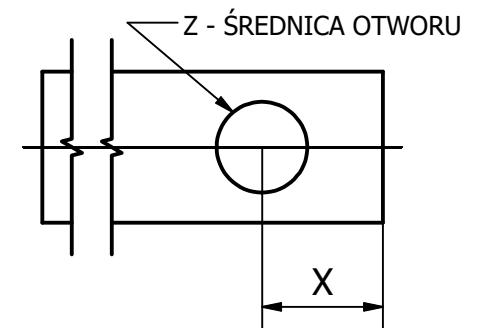
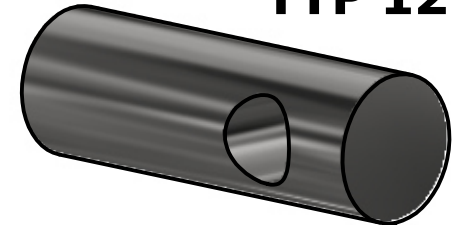

Przykład zamówienia i oznaczenia:  
krążniki gładkie

