



**TECHNICAL**

GRZEGORZ TĘGOS

[www.technical.pl](http://www.technical.pl)

Krażniki kierunkowe - rolki kierunkowe do sterowania taśm transportujących w transporterach taśmowych powierzchniowych

## KRAŻNIK KIERUNKOWY

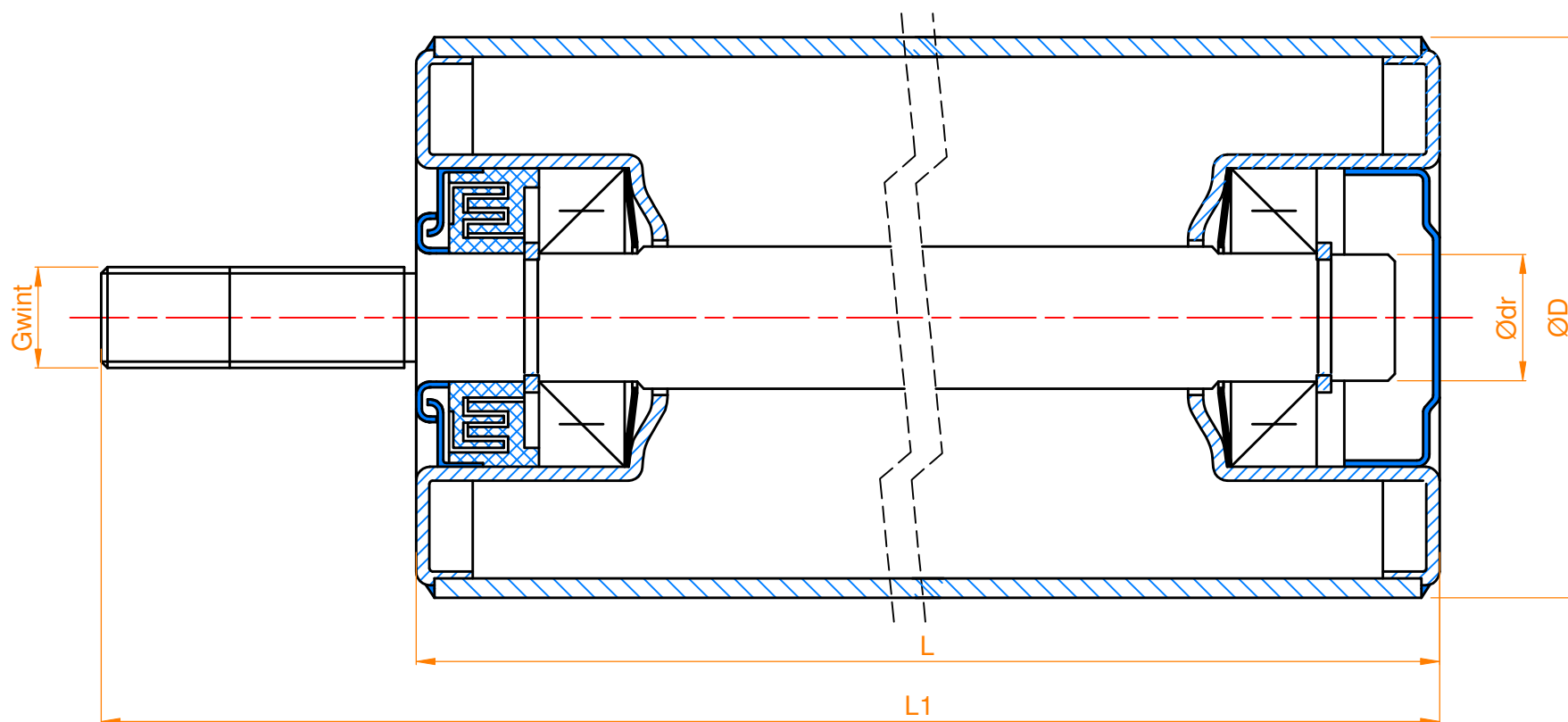

# KOŃCÓWKI OSI

**TYP 1**

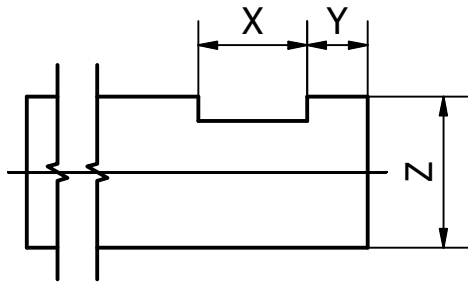
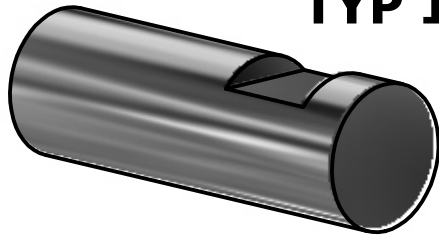

**TYP 2**

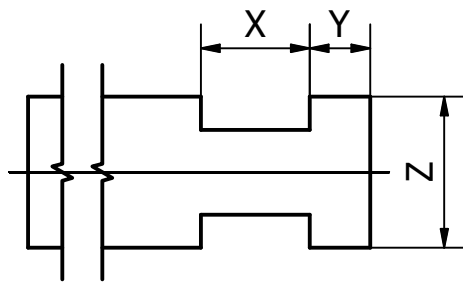
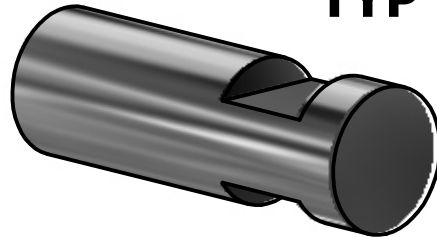

**TYP 3**

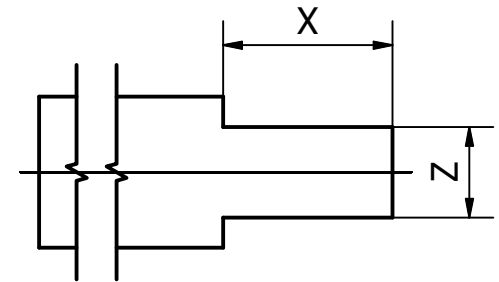
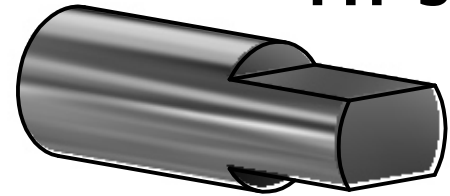

**TYP 4**

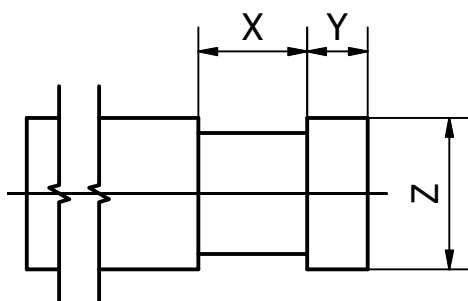
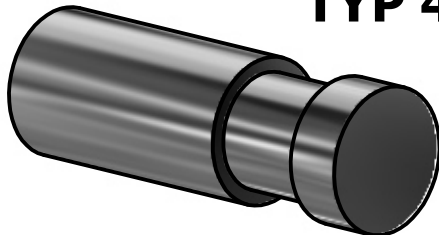

**TYP 5**

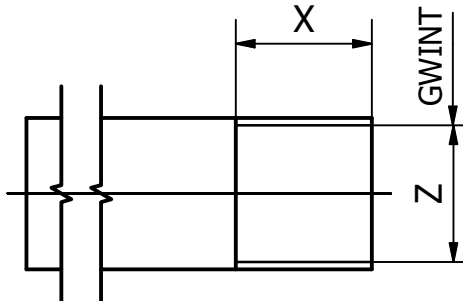
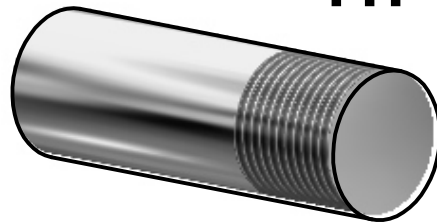

**TYP 6**

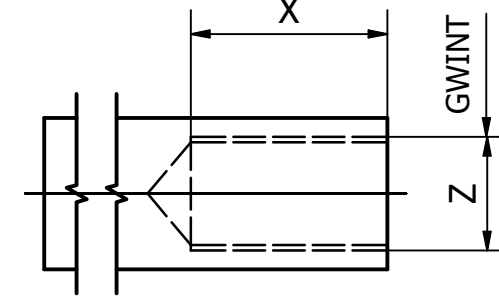
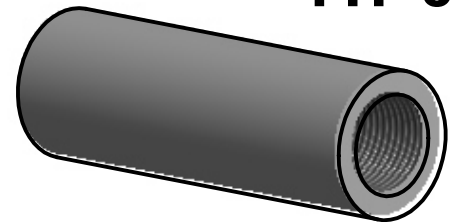

# KOŃCÓWKI OSI

**TYP 7**

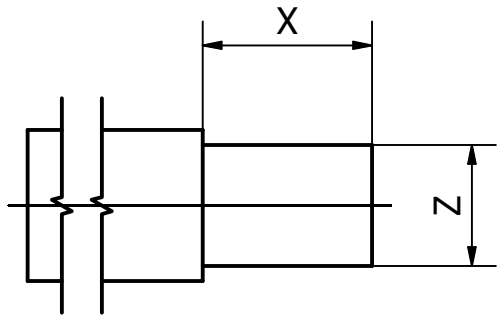
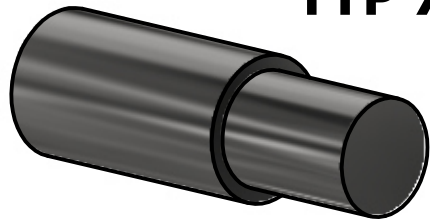

**TYP 8**

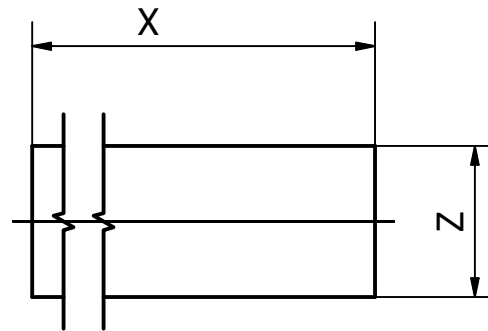

**TYP 9**

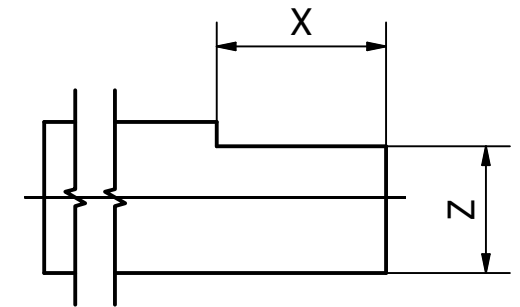
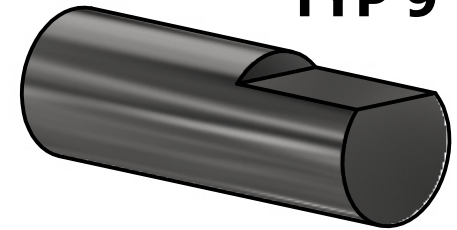

**TYP 10**

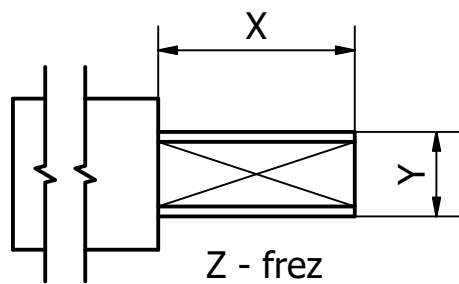
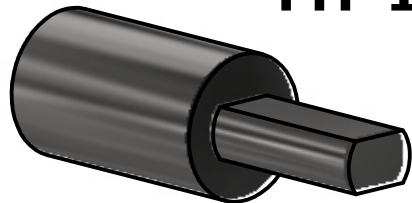

**TYP 11**

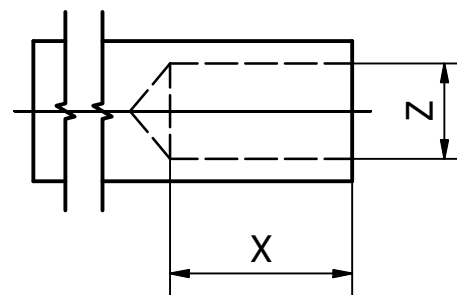
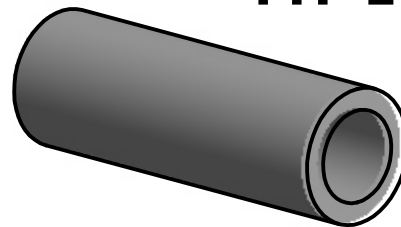

**TYP 12**

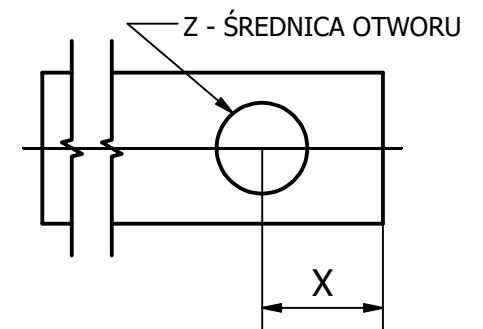
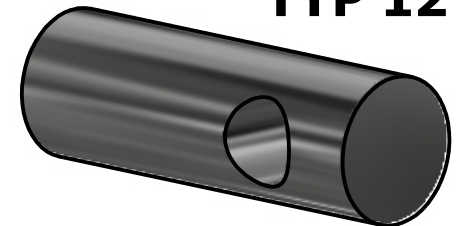

## Przykład zamówienia i oznaczenia krążnika

