

DYSTRYBUTOR

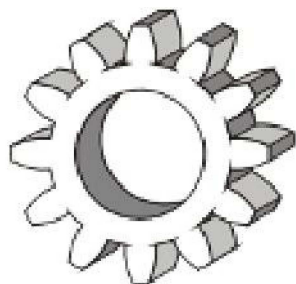

TECHNICAL

GRZEGORZ TĘGOS

TECHNIKA NAPEWU I TRANSMISJI MOCY

62-600 Koło, ul. Toruńska 212
tel. 0-63/ 27 25 478 / fax. 0-63/ 26 16 258

www.technical.pl
biuro@technical.pl

Sklep internetowy
www.sklep.technical.pl

**Pasy zębate z metra
Elatech SIT
katalog ogólny**



Antriebsselemente

ELATECH® M and V

The timing belts manufactured by ELATECH® have been designed to comply with every need of the design engineer in linear motion, power transmission and in conveying applications where precise synchronisation is needed. ELATECH® timing belts are manufactured with the body in thermoplastic polyurethane with excellent wear resistance and with high tensile strength steel cords. A special polyamide fabric on the tooth (on request) reduces the coefficient of friction, improves the tooth engagement and reduces noise.

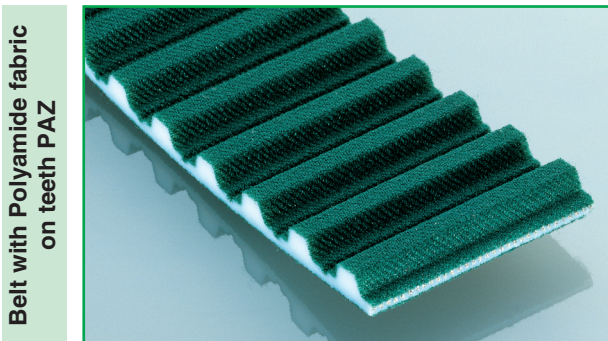
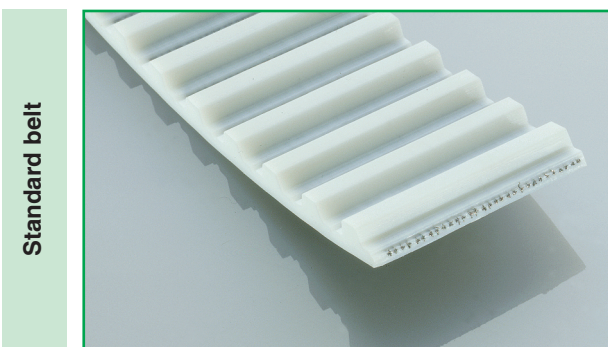

Product declaration

- ELATECH® belts are certified to be according RoHS 2011/65/UE
- On request, it is possible to deliver belts:
 - with antistatic properties according to ISO9563
 - other special certifications available on request

Colour

The standard colour ELATECH® timing belt is white. On demand it is possible to deliver belts in different colours.

Tension Cords

In order to maximize the application of ELATECH® timing belts, construction with special cords is available on request:

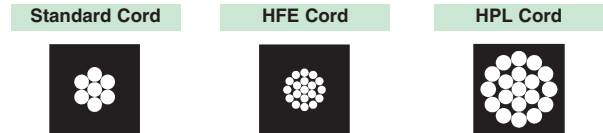

- **HPL** high performance cords: the cord cross section is increased compared with standard. This results in a lower belt elongation and more precise positioning accuracy.
- **HFE** high Flexibility cords: the cord cross section is spread on a higher number of single filaments. This results in a lower bending stress and therefore in a higher resistance at reverse bending of the cords. They allow using pulleys and idlers up to 30% smaller in diameter compared to standard.
- **INOX** stainless steel cords are suitable for application in aggressive environments. They have lower tensile strength than standard cords.
- **ARAMID**: increases belt flexibility and decreases belt weight.

It is to be noted that steel cords offer the best technical performances and dimensional stability of the belts. Belt length tolerances are valid for steel cord reinforcement. In case of other material (aramid, fibreglass) length tolerance may change.

For application with special cords ask our engineering department.

Mechanical properties:

- Excellent dimensional stability
- High abrasion resistance
- Low pretension and shaft load
- Maintenance free
- High linear and angular positioning precision
- High efficiency

Chemical properties:

High resistance to:

- Hydrolysis
- Ozone
- UVA
- Ageing
- Oils, greases and fats
- Gasoline
- Good resistance to acids
- Working temperatures range for standard material -10°C +80°C (peaks up to 110°C).
- For very low temperature special compound material is available on request (see dedicated table)
- Silicon free production

Executions

ELATECH® M

They are manufactured in rolls with standard length of 100 m. On request longer or shorter lengths are available. Main applications are linear drives.

Ordering example roll 100 m profile T :

ELATECH® "R" - Roll 100 m	R	025	T	10	A / Z
ELATECH® timing belt type "R"					
Width 25 mm (3 digits)					
Profile "T"					
Pitch 10 mm					
A= steel cords S= inox cords K= Kevlar® cords F= high flexibility cords P= high power cords					
Z= fabric on teeth (PAZ) R= fabric on back (PAR) D= fabric on PAZ + PAR					

Ordering example profile H cut to length:

ELATECH® "M" cut to length	M	100	H	A	01000 / Z
ELATECH® timing belt type "M"					
Width (x 0,254 = mm) - 3 digits					
Profile "H"					
A= stainless steel cords S= inox cords K= Kevlar® cords F= high flexibility cords P= high power cords					
Length 1000 mm (5 digits)					
Z= fabric on teeth (PAZ) R= fabric on back (PAR) D= fabric on PAZ + PAR					

ELATECH® V

They are jointed belts manufactured from open-end ELATECH® belts. Thanks to the specific manufacturing process, any length may be obtained tooth by tooth. Free combinations with special backing materials and welded profiles, make ELATECH® V belts ideal in synchronized conveying and highly specialised applications.

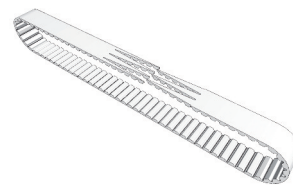
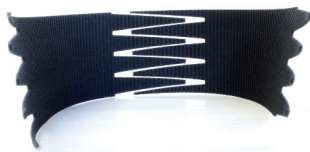

Ordering example profile AT :

ELATECH® "V" jointed	V	020	AT5	A	03410 / Z
ELATECH timing belt type "V" jointed					
Width 20 mm (3 digits)					
Profile "AT" - Pitch 5 mm					
A= stainless steel cords S= inox cords K= Kevlar® cords F= high flexibility cords P= high power cords					
Length 3410 mm (5 digits)					
Z= fabric on teeth (PAZ) R= fabric on back (PAR) D= fabric on PAZ + PAR					

Ordering example profile XL :

ELATECH® "V" jointed	V	150	XL	A	00750 / Z
ELATECH timing belt type "V" jointed					
Width (x 0,254 = mm) - 3 digits					
Profile "XL"					
A= stainless steel cords S= inox cords K= Kevlar® cords F= high flexibility cords P= high power cords					
Length 750 mm (5 digits)					
Z= fabric on teeth (PAZ) R= fabric on back (PAR) D= fabric on PAZ + PAR					

T 2,5

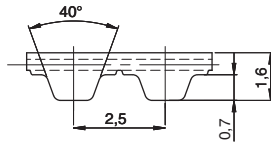

Belt characteristics

- Polyurethane timing belt with steel tension cords
- Tooth profile according to ISO 17396
- Metric pitch 2,5 mm
- Ideal for drives where high belt flexibility is requested
- Widely used for conveying, linear drive and light power transmission applications
- Color: white

- Width tolerance: $\pm 0,3$ [mm]
- Length tolerance: $\pm 0,5$ [mm/m]
- Thickness tolerance: $\pm 0,15$ [mm]

Technical Data

Belt width b [mm]	Allowable tensile load Type M F_{Tzul} [N]	Allowable tensile load Type V F_{Tzul} [N]	Breaking load Type M F_{Br} [N]	Specific spring rate C_{spez} [N]	Weight [kg/m]
4	130	-	500	32500	0,004
6	190	-	750	47500	0,007
10	320	160	1250	80000	0,011
20	700	350	2750	175000	0,022
50	1860	930	7250	465000	0,055
100	3780	1890	14750	945000	0,110

Other widths are available on request.

Load / Elongation [%]

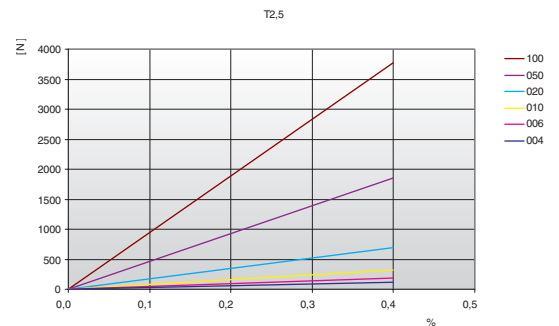

Tooth shear strength

rpm	F_{Uspez} [N/cm]	rpm	F_{Uspez} [N/cm]	rpm	F_{Uspez} [N/cm]	rpm	F_{Uspez} [N/cm]
0	9,10	700	6,13	1800	5,11	4000	4,22
20	8,77	800	5,99	1900	5,05	4500	4,09
40	8,51	900	5,86	2000	4,99	5000	3,97
60	8,30	1000	5,75	2200	4,88	5500	3,86
80	8,13	1100	5,64	2400	4,79	6000	3,76
100	8,00	1200	5,55	2600	4,70	6500	3,67
200	7,39	1300	5,46	2800	4,62	7000	3,59
300	7,00	1400	5,38	3000	4,54	7500	3,51
400	6,71	1440	5,35	3200	4,47	8000	3,44
500	6,48	1500	5,31	3400	4,40	8500	3,37
600	6,29	1600	5,24	3600	4,34	9000	3,30
700	6,13	1700	5,17	3800	4,28	10000	3,18

Tooth shear strength / rpm

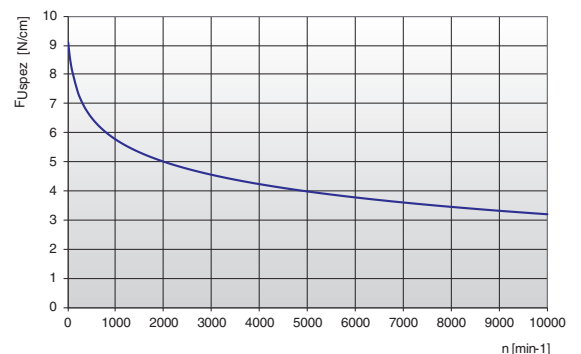

The specific load F_{Uspez} is the maximum load which one single belt tooth 1 cm wide can withstand in all operating conditions.

This force is related to the drive rpm.

The total load F_u transmissible by the belt in the drive is calculated by:

$$F_u [N] = F_{Uspez} \cdot Z_e \cdot b$$

- F_u [N] = peripheral force
- F_{Uspez} [N/cm] = specific load
- Z_e = number of teeth in mesh in the small pulley
- Z_{emax} = max. no of teeth in mesh to be considered for the calculation of the drive
- Z_{emax} = 12 for ELATECH® M
- Z_{emax} = 6 for ELATECH® V
- b [cm] = belt width in cm

T 2,5

Flexibility

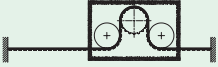
Minimum pulley number of teeth and minimum idler diameter		Type of cord
		STANDARD
Drive without reverse bending 	Timing pulley z_{min}	15
	Flat idler running on belt teeth d_{min}	15 mm
Drive with reverse bending 	Timing pulley z_{min}	18
	Flat idler running on belt back d_{min}	18 mm

Timing pulleys

Z	da	dw	Z	da	dw	Z	da	dw	Z	da	dw
10	7,46	7,96	43	33,72	34,22	76	59,98	60,48	109	86,24	86,74
11	8,25	8,75	44	34,52	35,02	77	60,78	61,28	110	87,04	87,54
12	9,05	9,55	45	35,31	35,81	78	61,57	62,07	111	87,83	88,33
13	9,85	10,35	46	36,11	36,61	79	62,37	62,87	112	88,63	89,13
14	10,64	11,14	47	36,90	37,40	80	63,16	63,66	113	89,43	89,93
15	11,44	11,94	48	37,70	38,20	81	63,96	64,46	114	90,22	90,72
16	12,23	12,73	49	38,49	38,99	82	64,76	65,26	115	91,02	91,52
17	13,03	13,53	50	39,29	39,79	83	65,55	66,05	116	91,81	92,31
18	13,82	14,32	51	40,09	40,59	84	66,35	66,85	117	92,61	93,11
19	14,62	15,12	52	40,88	41,38	85	67,14	67,64	118	93,40	93,90
20	15,42	15,92	53	41,68	42,18	86	67,94	68,44	119	94,20	94,70
21	16,21	16,71	54	42,47	42,97	87	68,73	69,23	120	95,00	95,50
22	17,01	17,51	55	43,27	43,77	88	69,53	70,03	121	95,79	96,29
23	17,80	18,30	56	44,06	44,56	89	70,33	70,83	122	96,59	97,09
24	18,60	19,10	57	44,86	45,36	90	71,12	71,62	123	97,38	97,88
25	19,39	19,89	58	45,66	46,16	91	71,92	72,42	124	98,18	98,68
26	20,19	20,69	59	46,45	46,95	92	72,71	73,21	125	98,97	99,47
27	20,99	21,49	60	47,25	47,75	93	73,51	74,01	126	99,77	100,27
28	21,78	22,28	61	48,04	48,54	94	74,31	74,81	127	100,57	101,07
29	22,58	23,08	62	48,84	49,34	95	75,10	75,60	128	101,36	101,86
30	23,37	23,87	63	49,64	50,14	96	75,90	76,40	129	102,16	102,66
31	24,17	24,67	64	50,43	50,93	97	76,69	77,19	130	102,95	103,45
32	24,97	25,47	65	51,23	51,73	98	77,49	77,99	131	103,75	104,25
33	25,76	26,26	66	52,02	52,52	99	78,28	78,78	132	104,55	105,05
34	26,56	27,06	67	52,82	53,32	100	79,08	79,58	133	105,34	105,84
35	27,35	27,85	68	53,61	54,11	101	79,88	80,38	134	106,14	106,64
36	28,15	28,65	69	54,41	54,91	102	80,67	81,17	135	106,93	107,43
37	28,94	29,44	70	55,21	55,71	103	81,47	81,97	136	107,73	108,23
38	29,74	30,24	71	56,00	56,50	104	82,26	82,76	137	108,52	109,02
39	30,54	31,04	72	56,80	57,30	105	83,06	83,56	138	109,32	109,82
40	31,33	31,83	73	57,59	58,09	106	83,85	84,35	139	110,12	110,62
41	32,13	32,63	74	58,39	58,89	107	84,65	85,15	140	110,91	111,41
42	32,92	33,42	75	59,18	59,68	108	85,45	85,95			

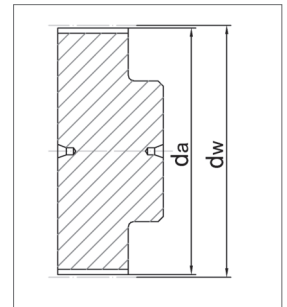

T 5

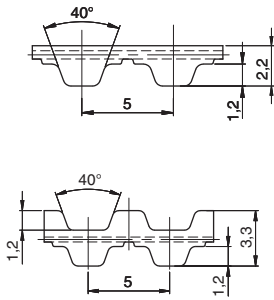

Belt characteristics

- Polyurethane timing belt with steel tension cords
- Tooth profile according to ISO 17396
- Metric pitch 5 mm
- Ideal for drives where high belt flexibility is requested
- Widely used for conveying, linear drive and light power transmission applications
- Double sided tooth construction available

- Width tolerance: $\pm 0,5$ [mm]
- Length tolerance: $\pm 0,5$ [mm/m]
- Thickness tolerance: $\pm 0,15$ [mm]

Technical Data

Belt width b [mm]	Allowable tensile load Type M F_{Tzul} [N]	Allowable tensile load Type V F_{Tzul} [N]	Breaking load Type M F_{Br} [N]	Specific spring rate C_{spez} [N]	Weight [kg/m]
10	320	160	1250	80000	0,021
16	540	270	2125	135000	0,034
25	900	450	3500	225000	0,053
32	1150	575	4500	287500	0,067
50	1860	930	7250	465000	0,105
75	2820	1410	11000	705000	0,158
100	3780	1890	14750	945000	0,210

Other widths are available on request.

Load / Elongation [%]

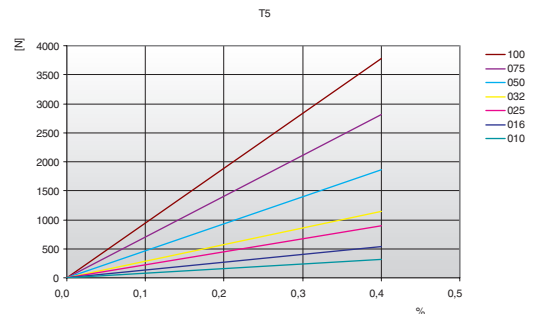

Tooth shear strength

rpm	F_{Uspez} [N/cm]	rpm	F_{Uspez} [N/cm]	rpm	F_{Uspez} [N/cm]	rpm	F_{Uspez} [N/cm]
0	24,70	800	17,02	1900	14,21	4500	11,25
20	24,07	900	16,65	2000	14,03	5000	10,88
40	23,53	1000	16,32	2200	13,71	5500	10,55
60	23,05	1100	16,01	2400	13,42	6000	10,24
80	22,64	1200	15,73	2600	13,14	6500	9,96
100	22,28	1300	15,47	2800	12,89	7000	9,70
200	20,90	1400	15,22	3000	12,65	7500	9,46
300	19,89	1440	15,13	3200	12,43	8000	9,23
400	19,10	1500	15,00	3400	12,22	8500	9,01
500	18,45	1600	14,78	3600	12,03	9000	8,81
600	17,91	1700	14,58	3800	11,84	9500	8,62
700	17,44	1800	14,39	4000	11,66	10000	8,44

Tooth shear strength / rpm

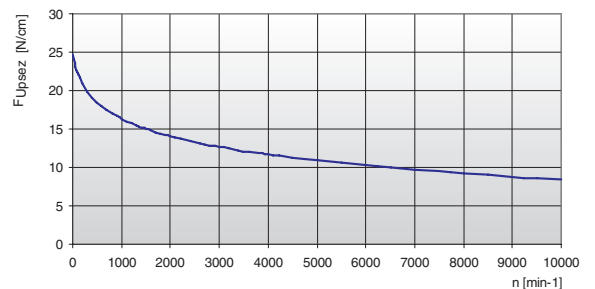

The specific load F_{Uspez} is the maximum load which one single belt tooth 1 cm wide can withstand in all operating conditions. This force is related to the drive rpm.

The total load F_u transmissible by the belt in the drive is calculated by:

$$F_u [N] = F_{Uspez} \cdot Z_e \cdot b$$

- $F_u [N]$ = peripheral force
- $F_{Uspez} [N/cm]$ = specific load
- Z_e = number of teeth in mesh in the small pulley
- Z_{emax} = max. no of teeth in mesh to be considered for the calculation of the drive
- Z_{emax} = 12 for ELATECH® M
- Z_{emax} = 6 for ELATECH® V
- $b [cm]$ = belt width in cm

T 5

Specialties

Belt width b [mm]	ARAMID CORD		HPL High Performance	
	F _{Tzul} [N] M type	F _{Br} [N]	F _{Tzul} [N] M type	F _{Br} [N]
10	700	2800	920	3360
16	1190	4760	1610	5880
25	1960	7840	2645	9660
32	2520	10080	3450	12600
50	4060	16240	5520	20160
75	6160	24640	8395	30660
100	8260	33040	11270	41160
150	-	-	16905	61740

Flexibility

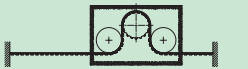
Minimum pulley number of teeth and minimum idler diameter		Type of cord		
		STANDARD	ARAMID	HPL
Drive without reverse bending 	Timing pulley z _{min}	10	10	24
	Flat idler running on belt teeth d _{min}	30 mm	30 mm	60 mm
Drive with reverse bending 	Timing pulley z _{min}	15	15	38
	Flat idler running on belt back d _{min}	30 mm	30 mm	60 mm

Timing pulleys

z	da	dw	z	da	dw	z	da	dw	z	da	dw
10	15,05	15,92	40	62,85	63,66	70	110,60	111,44	100	158,35	159,20
11	16,65	17,51	41	64,4	65,27	71	112,20	113,03	101	159,95	160,79
12	18,25	19,10	42	66	66,86	72	113,75	114,62	102	161,55	162,38
13	19,85	20,70	43	67,7	68,46	73	115,35	116,22	103	163,10	163,97
14	21,45	22,29	44	69,2	70,05	74	116,95	117,81	104	164,70	165,57
15	23,05	23,88	45	70,8	71,64	75	118,55	119,40	105	166,30	167,16
16	24,60	25,47	46	72,4	73,23	76	120,15	120,99	106	167,90	168,75
17	26,20	27,06	47	73,95	74,82	77	121,75	122,58	107	169,50	170,34
18	27,80	28,65	48	75,55	76,42	78	123,30	124,18	108	171,10	171,94
19	29,40	30,25	49	77,15	78,01	79	124,90	125,77	109	172,65	173,53
20	31,00	31,83	50	78,75	79,60	80	126,50	127,36	110	174,25	175,12
21	32,70	33,43	51	80,35	81,19	81	128,10	128,95	111	175,85	176,71
22	34,25	35,02	52	81,95	82,78	82	129,70	130,54	112	177,45	178,30
23	35,85	36,62	53	83,5	84,38	83	131,30	132,14	113	179,05	179,84
24	37,40	38,21	54	85,1	85,97	84	132,85	133,73	114	180,65	181,49
25	39,00	39,80	55	86,7	87,54	85	134,45	135,32	115	182,23	183,08
26	40,60	41,39	56	88,3	89,15	86	136,05	136,91	116	183,82	184,67
27	42,20	42,98	57	89,9	90,74	87	137,65	138,50	117	185,42	186,26
28	43,75	44,58	58	91,5	92,34	88	139,25	140,10	118	187,01	187,86
29	45,35	46,17	59	93,05	93,93	89	140,85	141,69	119	188,61	189,45
30	46,95	47,76	60	94,65	95,52	90	142,45	143,28	120	190,21	191,04
31	48,55	49,35	61	96,25	97,11	91	144,00	144,87			
32	50,10	50,94	62	97,85	98,70	92	145,60	146,46			
33	51,70	52,54	63	99,45	100,30	93	147,20	148,06			
34	53,25	54,13	64	101,05	101,89	94	148,80	149,65			
35	54,85	55,72	65	102,65	103,48	95	150,40	151,24			
36	56,45	57,31	66	104,2	105,07	96	152,00	152,83			
37	58,05	58,90	67	105,8	106,66	97	153,55	154,42			
38	59,65	60,50	68	107,40	108,26	98	155,15	156,02			
39	61,25	62,09	69	109,00	109,85	99	156,75	157,61			

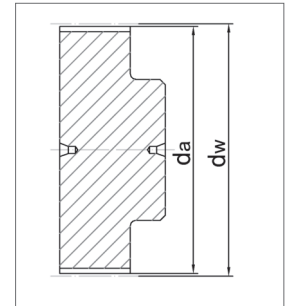

T 10

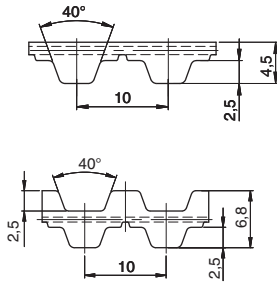

Belt characteristics

- Polyurethane timing belt with steel tension cords
- Tooth profile according to ISO 17396
- Metric pitch 10 mm
- Ideal for drives where high belt flexibility is requested
- Widely used for conveying, linear drive and medium power transmission applications
- Double sided tooth construction available

- Width tolerance: $\pm 0,5$ [mm]
- Length tolerance: $\pm 0,5$ [mm/m]
- Thickness tolerance: $\pm 0,2$ [mm]

Technical Data

Belt width b [mm]	Allowable tensile load Type M F_{Tzul} [N]	Allowable tensile load Type V F_{Tzul} [N]	Breaking load Type M F_{Br} [N]	Specific spring rate C_{spez} [N]	Weight [kg/m]
10	920	460	3360	230000	0,05
16	1610	805	5880	402500	0,07
25	2650	1325	9660	662500	0,11
32	3450	1725	12600	862500	0,15
50	5520	2760	20160	1380000	0,23
75	8400	4200	30660	2100000	0,34
100	11270	5635	41160	2817500	0,45
150	17020	8510	62160	4255000	0,68
200*	11270	5635	41160	2817500	0,60

Other widths are available on request. * = double cords spacing

Load / Elongation [%]

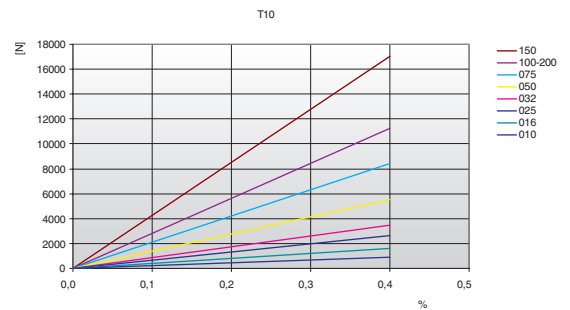

Tooth shear strength

rpm	F_{Uspez} [N/cm]	rpm	F_{Uspez} [N/cm]	rpm	F_{Uspez} [N/cm]	rpm	F_{Uspez} [N/cm]
0	51,80	800	33,34	1900	26,53	4500	19,40
20	50,32	900	32,44	2000	26,12	5000	18,51
40	49,04	1000	31,63	2200	25,34	5500	17,70
60	47,92	1100	30,89	2400	24,63	6000	16,97
80	46,95	1200	30,21	2600	23,97	6500	16,29
100	46,11	1300	29,58	2800	23,36	7000	15,66
200	42,75	1400	28,99	3000	22,78	7500	15,07
300	40,28	1440	28,76	3200	22,25	8000	14,52
400	38,36	1500	28,44	3400	21,74	8500	14,00
500	36,80	1600	27,92	3600	21,27	9000	13,51
600	35,49	1700	27,43	3800	20,81	9500	13,05
700	34,35	1800	26,97	4000	20,39	10000	12,61

Tooth shear strength / rpm

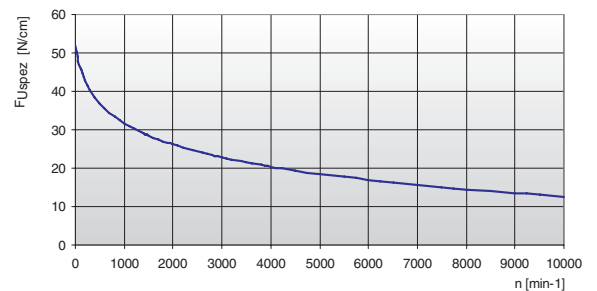

The specific load F_{Uspez} is the maximum load which one single belt tooth 1 cm wide can withstand in all operating conditions. This force is related to the drive rpm.

The total load F_u transmissible by the belt in the drive is calculated by:

$$F_u [N] = F_{Uspez} \cdot Z_e \cdot b$$

- F_u [N] = peripheral force
- F_{Uspez} [N/cm] = specific load
- Z_e = number of teeth in mesh in the small pulley
- Z_{emax} = max. no of teeth in mesh to be considered for the calculation of the drive
- Z_{emax} = 12 for ELATECH® M
- Z_{emax} = 6 for ELATECH® V
- b [cm] = belt width in cm

T 10

Specialties

Belt width b [mm]	ARAMID CORD		STAINLESS STEEL		HPL High Performance		HFE High Flexibility	
	F_{Tzul} [N] M type	F_{Br} [N]	F_{Tzul} [N] M type	F_{Br} [N]	F_{Tzul} [N] M type	F_{Br} [N]	F_{Tzul} [N] M type	F_{Br} [N]
10	880	3600	600	2400	-	-	960	3440
16	1540	6300	1050	4200	2450	9500	1680	6020
25	2530	10350	1730	6900	4165	16150	2760	9890
32	3300	13500	2250	9000	5390	20900	3600	12900
50	5280	21600	3600	14400	8575	33250	5760	20640
75	8030	32850	-	-	12990	50350	-	-
100	10780	44100	-	-	17400	67450	-	-
150	16280	66600	-	-	-	-	-	-
200*	10780	44100	-	-	-	-	-	-

* = double cords spacing

Flexibility

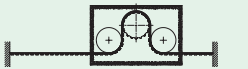
Minimum pulley number of teeth and minimum idler diameter		Type of cord				
		STANDARD	ARAMID	STAINLESS	HPL	HFE
Drive without reverse bending 	Timing pulley z_{min}	12	15	15	15	10
	Flat idler running on belt teeth d_{min}	60 mm	60 mm	60 mm	100 mm	50 mm
Drive with reverse bending 	Timing pulley z_{min}	20	20	40	30	15
	Flat idler running on belt back d_{min}	60 mm	60 mm	120 mm	100 mm	50 mm

Timing pulleys

z	da	dw	z	da	dw	z	da	dw	z	da	dw
10	30,05	31,84	40	125,45	127,32	71	224,15	225,99	101	319,65	321,48
11	33,25	35,02	41	128,65	130,50	72	227,30	229,18	102	322,80	324,66
12	36,35	38,20	42	131,85	133,69	73	230,50	232,36	103	326,00	327,85
13	39,50	41,38	44	138,20	140,05	74	233,70	235,54	104	329,20	331,03
14	42,70	44,56	45	141,40	143,24	75	236,90	238,72	105	332,35	334,21
15	45,90	47,75	46	144,60	146,42	76	240,05	241,94	106	335,55	337,40
16	49,05	50,93	47	147,75	149,60	77	243,25	245,09	107	338,75	340,58
17	52,25	54,11	48	150,95	152,78	78	246,40	248,27	108	341,95	343,76
18	55,45	57,29	49	154,10	155,97	79	249,60	251,46	109	345,15	346,95
19	58,65	60,48	50	157,30	159,15	80	252,80	254,64	110	348,30	350,13
20	61,80	63,66	51	160,50	162,33	81	256,00	257,82	111	351,45	353,31
21	65,00	66,84	52	163,65	165,52	82	259,15	261,00	112	354,65	356,50
22	68,15	70,03	53	166,85	168,70	83	262,30	264,19	113	357,80	359,68
23	71,35	73,20	54	170,05	171,88	84	265,50	267,37	114	361,00	362,86
24	74,55	76,39	55	173,20	175,06	85	268,70	270,55	115	364,19	366,04
25	77,70	79,58	56	176,40	178,25	86	271,90	273,74	116	367,39	369,23
26	80,90	82,76	57	179,60	181,43	87	275,05	276,92	117	370,56	372,41
27	84,10	85,95	58	182,75	184,61	88	278,25	280,10	118	373,76	375,59
28	87,25	89,12	59	185,95	187,80	89	281,45	283,28	119	376,93	378,78
29	90,45	92,21	60	189,10	190,98	90	284,60	286,47	120	380,11	381,96
30	93,65	95,49	61	192,30	194,16	91	287,80	289,65			
31	96,85	98,67	62	195,50	197,35	92	291,00	292,84			
32	100,00	101,86	63	198,65	200,53	93	294,20	296,02			
33	103,20	105,04	64	201,85	203,71	94	297,35	299,20			
34	106,40	108,22	65	205,05	206,90	95	300,55	302,39			
35	109,55	111,41	66	208,20	210,08	96	303,75	305,57			
36	112,75	114,59	67	211,40	213,26	97	306,90	308,75			
37	115,90	117,77	68	214,60	216,44	98	310,10	311,93			
38	119,10	120,95	69	217,75	219,63	99	313,25	315,12			
39	122,30	124,14	70	220,95	222,81	100	316,45	318,30			

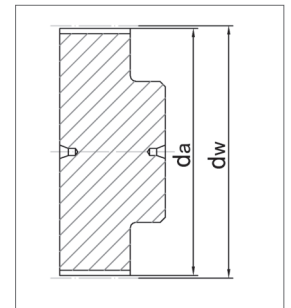

T 20

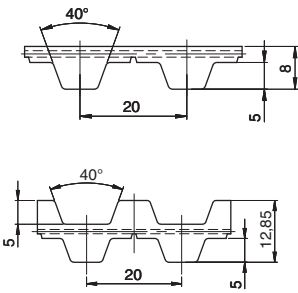

Belt characteristics

- Polyurethane timing belt with steel tension cords
- Tooth profile according to ISO 17396
- Metric pitch 20 mm
- Ideal for drives where high belt flexibility is requested
- Widely used for conveying, linear drive and heavy power transmission applications
- Double sided tooth construction available

- Width tolerance: $\pm 1,0$ [mm]
- Length tolerance: $\pm 0,5$ [mm/m]
- Thickness tolerance: $\pm 0,4$ [mm]

Technical Data

Belt width b [mm]	Allowable tensile load Type M F_{Tzul} [N]	Allowable tensile load Type V F_{Tzul} [N]	Breaking load Type M F_{Br} [N]	Specific spring rate C_{spez} [N]	Weight [kg/m]
25	4170	2085	16150	1042500	0,20
32	5390	2695	20900	1347500	0,26
50	8580	4290	33250	2145000	0,41
75	12990	6495	50350	3247500	0,61
100	17400	8700	67450	4350000	0,82
150	26220	13110	101650	6555000	1,23

Load / Elongation [%]

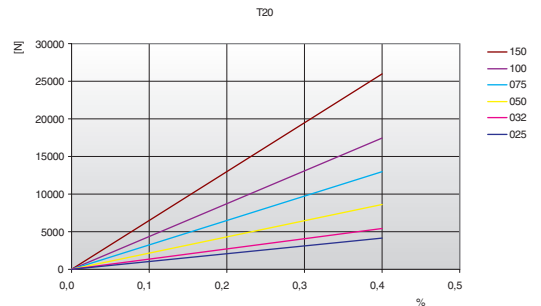

Other widths are available on request.

Tooth shear strength

rpm	F_{Uspez} [N/cm]	rpm	F_{Uspez} [N/cm]	rpm	F_{Uspez} [N/cm]	rpm	F_{Uspez} [N/cm]
0	104,50	800	62,15	1900	46,88	4500	30,92
20	101,10	900	60,13	2000	45,94	5000	28,93
40	98,15	1000	58,31	2200	44,20	5500	27,14
60	95,58	1100	56,64	2400	42,61	6000	25,49
80	93,35	1200	55,11	2600	41,13	6500	23,97
100	91,41	1300	53,70	2800	39,77	-	-
200	83,50	1400	52,38	3000	38,49	-	-
300	77,84	1440	51,87	3200	37,29	-	-
400	73,49	1500	51,14	3400	36,16	-	-
500	69,96	1600	49,98	3600	35,10	-	-
600	66,98	1700	48,89	3800	34,09	-	-
700	64,41	1800	47,86	4000	33,13	-	-

Tooth shear strength / rpm

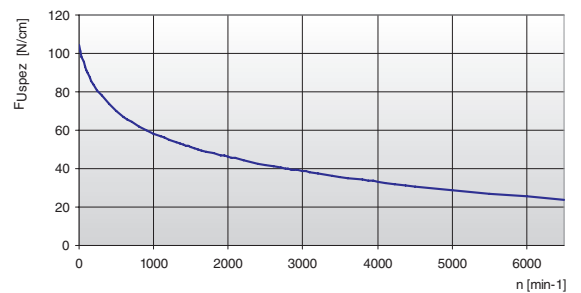

The specific load F_{Uspez} is the maximum load which one single belt tooth 1 cm wide can withstand in all operating conditions. This force is related to the drive rpm.

The total load F_u transmissible by the belt in the drive is calculated by:

$$F_u [N] = F_{Uspez} \cdot Z_e \cdot b$$

- $F_u [N]$ = peripheral force
- $F_{Uspez} [N/cm]$ = specific load
- Z_e = number of teeth in mesh in the small pulley
- Z_{emax} = max. no of teeth in mesh to be considered for the calculation of the drive
- Z_{emax} = 12 for ELATECH® M
- Z_{emax} = 6 for ELATECH® V
- $b [cm]$ = belt width in cm

T 20

Specialties

Belt width b [mm]	ARAMID CORD		STAINLESS STEEL		HFE High Flexibility	
	F _{Tzul} [N] M type	F _{Br} [N]	F _{Tzul} [N] M type	F _{Br} [N]	F _{Tzul} [N] M type	F _{Br} [N]
25	3740	17000	3060	12750	3400	14450
32	4840	22000	3960	16500	4400	18700
50	7700	35000	6300	26250	7000	29750
75	11660	53000	-	-	-	-
100	15620	71000	-	-	-	-
150	24300	110000	-	-	-	-

Flexibility

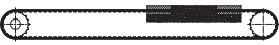
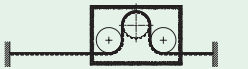
Minimum pulley number of teeth and minimum idler diameter		Type of cord			
		STANDARD	ARAMID	STAINLESS	HFE
Drive without reverse bending 	Timing pulley z _{min}	15	15	20	12
	Flat idler running on belt teeth d _{min}	120 mm	120 mm	130 mm	100 mm
Drive with reverse bending 	Timing pulley z _{min}	25	25	30	22
	Flat idler running on belt back d _{min}	120 mm	120 mm	150 mm	120 mm

Timing pulleys

z	da	dw	z	da	dw	z	da	dw	z	da	dw
15	92,65	95,49	45	283,60	286,47	75	474,60	477,45	105	665,60	668,43
16	99,00	101,86	46	289,95	292,84	76	480,95	483,82	106	671,95	674,80
17	105,40	108,22	47	296,35	299,21	77	487,35	490,19	107	678,30	681,17
18	111,75	114,59	48	302,70	305,58	78	493,70	496,56	108	684,70	687,54
19	118,10	120,96	49	309,10	311,93	79	500,05	502,91	109	691,05	693,89
20	124,50	127,32	50	315,45	318,30	80	506,45	509,28	110	697,40	700,26
21	130,75	133,69	51	321,80	324,67	81	512,80	515,65	111	703,80	706,63
22	137,20	140,06	52	328,15	331,03	82	519,15	522,02	112	710,15	712,99
23	143,55	146,43	53	334,50	337,40	83	525,55	528,39	113	716,50	719,36
24	149,95	152,78	54	340,90	343,76	84	531,90	534,74	114	722,90	725,73
25	156,30	159,15	55	347,25	350,13	85	538,25	541,11	115	729,24	732,09
26	162,65	165,52	56	353,60	356,50	86	544,60	547,48	116	735,61	738,46
27	169,00	171,89	57	360,00	362,86	87	551,00	553,85	117	741,96	744,83
28	175,40	178,25	58	366,35	369,23	88	557,35	560,22	118	748,34	751,19
29	181,75	184,62	59	372,75	375,59	89	563,70	566,57	119	754,70	757,56
30	188,10	190,99	60	379,10	381,96	90	570,10	572,94	120	761,07	763,93
31	194,50	197,35	61	385,45	388,33	91	576,45	579,31			
32	200,85	203,72	62	391,85	394,70	92	582,85	585,67			
33	207,20	210,09	63	398,20	401,06	93	589,20	592,04			
34	213,60	216,44	64	404,55	407,43	94	595,55	598,41			
35	219,95	222,81	65	410,95	413,80	95	601,90	604,77			
36	226,35	229,18	66	417,30	420,17	96	608,30	611,14			
37	232,70	235,54	67	423,65	426,52	97	614,65	617,51			
38	239,05	241,91	68	430,05	432,89	98	621,00	623,88			
39	245,40	248,28	69	436,40	439,26	99	627,35	630,25			
40	251,75	254,65	70	442,80	445,63	100	633,75	636,60			
41	258,15	261,02	71	449,15	451,99	101	640,10	642,97			
42	264,50	267,37	72	455,50	458,36	102	646,50	649,34			
43	270,85	273,74	73	461,85	464,73	103	652,85	655,71			
44	277,25	280,10	74	468,25	471,08	104	659,20	662,06			

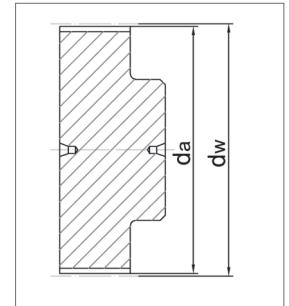

AT 3

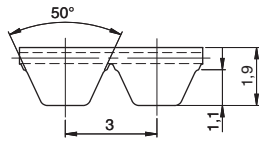

Belt characteristics

- Polyurethane timing belt with steel tension cords
- Tooth profile according to ISO 17396
- Metric pitch 3 mm
- Tooth profile and dimension are optimised to guarantee uniform load distribution and minimum deformation under load
- High resistance and low stretch steel cords to guarantee high stability and low elongation
- Reduced polygonal effect with reduced drive vibration
- Particularly suitable for linear drives and light power transmission applications with high axial and angular positioning accuracy.
- Negative length tolerance available on request

- Width tolerance: $\pm 0,5$ [mm]
- Length tolerance: $\pm 0,5$ [mm/m]
- Thickness tolerance: $\pm 0,2$ [mm]

Technical Data

Belt width b [mm]	Allowable tensile load Type M F_{Tzul} [N]	Allowable tensile load Type V F_{Tzul} [N]	Breaking load Type M F_{Br} [N]	Specific spring rate C_{spez} [N]	Weight [kg/m]
8	260	130	1000	65000	0,018
10	320	160	1250	80000	0,022
12	416	208	1625	104000	0,026
16	540	270	2125	135000	0,035
20	700	350	2750	175000	0,044
25	900	450	3500	225000	0,054

Other widths are available on request.

Load / Elongation [%]

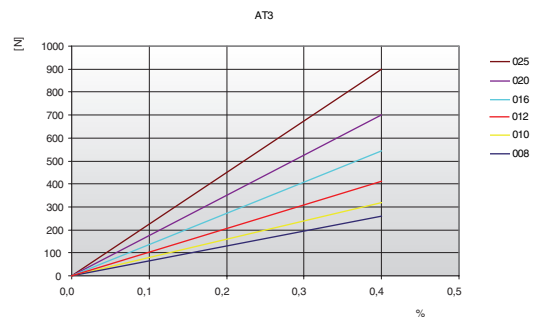

Tooth shear strength

rpm	F_{Uspez} [N/cm]	rpm	F_{Uspez} [N/cm]	rpm	F_{Uspez} [N/cm]	rpm	F_{Uspez} [N/cm]
0	32,50	800	25,62	1900	20,98	4500	15,64
20	32,13	900	25,05	2000	20,68	5000	14,96
40	31,79	1000	24,52	2200	20,11	5500	14,33
60	31,48	1100	24,02	2400	19,59	6000	13,76
80	31,19	1200	23,56	2600	19,10	6500	13,23
100	30,92	1300	23,13	2800	18,64	7000	12,74
200	29,86	1400	22,72	3000	18,22	7500	12,28
300	29,15	1440	22,57	3200	17,81	8000	11,84
400	28,47	1500	22,34	3400	17,43	8500	11,43
500	27,66	1600	21,97	3600	17,07	9000	11,05
600	26,92	1700	21,63	3800	16,73	9500	10,68
700	26,25	1800	21,29	4000	16,40	10000	10,34

Tooth shear strength / rpm

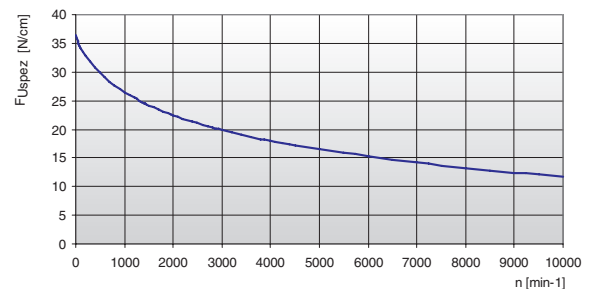

The specific load F_{Uspez} is the maximum load which one single belt tooth 1 cm wide can withstand in all operating conditions. This force is related to the drive rpm.

The total load F_u transmissible by the belt in the drive is calculated by:

$$F_u [N] = F_{Uspez} \cdot z_e \cdot b$$

- F_u [N] = peripheral force
- F_{Uspez} [N/cm] = specific load
- z_e = number of teeth in mesh in the small pulley
- z_{emax} = max. no of teeth in mesh to be considered for the calculation of the drive
- z_{emax} = 12 for ELATECH® M
- z_{emax} = 6 for ELATECH® V
- b [cm] = belt width in cm

AT 3

Flexibility

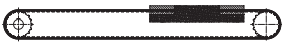
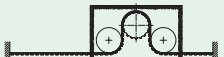
Minimum pulley number of teeth and minimum idler diameter		Type of cord
		STANDARD
Drive without reverse bending 	Timing pulley z_{min}	15
	Flat idler running on belt teeth d_{min}	20 mm
Drive with reverse bending 	Timing pulley z_{min}	20
	Flat idler running on belt back d_{min}	20 mm

Timing pulleys

z	da	dw
15	13,92	14,32
16	14,87	15,28
17	15,82	16,23
18	16,78	17,19
19	17,73	18,14
20	18,69	19,10
21	19,64	20,05
22	20,60	21,01
23	21,55	21,96
24	22,51	22,92
25	23,46	23,87
26	24,42	24,83
27	25,37	25,78
28	26,33	26,74
29	27,28	27,69
30	28,24	28,65
31	29,19	29,60
32	30,15	30,56
33	31,10	31,51
34	32,06	32,47
35	33,01	33,42
36	33,97	34,38
37	34,92	35,33
38	35,88	36,29
39	36,83	37,24
40	37,79	38,20
41	38,74	39,15
42	39,70	40,11
43	40,65	41,06
44	41,61	42,02

z	da	dw
45	42,56	42,97
46	43,52	43,93
47	44,47	44,88
48	45,43	45,84
49	46,38	46,79
50	47,34	47,75
51	48,29	48,70
52	49,25	49,66
53	50,20	50,61
54	51,16	51,57
55	52,11	52,52
56	53,07	53,48
57	54,02	54,43
58	54,98	55,39
59	55,93	56,34
60	56,89	57,30
61	57,84	58,25
62	58,80	59,21
63	59,75	60,16
64	60,71	61,12
65	61,66	62,07
66	62,62	63,03
67	63,57	63,98
68	64,53	64,94
69	65,48	65,89
70	66,44	66,85
71	67,39	67,80
72	68,35	68,75

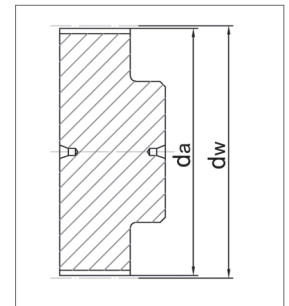

AT 5

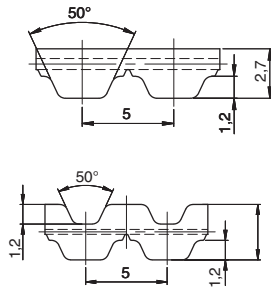

Belt characteristics

- Polyurethane timing belt with steel tension cords
- Tooth profile according to ISO 17396
- Metric pitch 5 mm
- Tooth profile and dimension are optimised to guarantee uniform load distribution and minimum deformation under load
- High resistance and low stretch steel cords to guarantee high stability and low elongation
- Reduced polygonal effect with reduced drive vibration
- Particularly suitable for linear drives and light power transmission applications with high axial and angular positioning accuracy
- Double sided tooth construction available
- Negative length tolerance available on request

- Width tolerance: $\pm 0,5$ [mm]
- Length tolerance: $\pm 0,5$ [mm/m]
- Thickness tolerance: $\pm 0,2$ [mm]

Technical Data

Belt width b [mm]	Allowable tensile load Type M F_{Tzul} [N]	Allowable tensile load Type V F_{Tzul} [N]	Breaking load Type M F_{Br} [N]	Specific spring rate C_{spez} [N]	Weight [kg/m]
10	640	320	2160	160000	0,03
16	1120	560	3780	280000	0,05
25	1840	920	6210	460000	0,09
32	2400	1200	8100	600000	0,11
50	3840	1920	12960	960000	0,17
75	5840	2920	19710	1460000	0,26
100	7840	3920	26460	1960000	0,34

Load / Elongation [%]

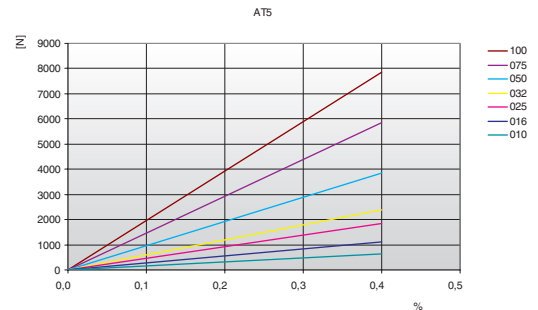

Other widths are available on request.

Tooth shear strength

rpm	F_{Uspez} [N/cm]	rpm	F_{Uspez} [N/cm]	rpm	F_{Uspez} [N/cm]	rpm	F_{Uspez} [N/cm]
0	36,40	800	27,69	1900	22,73	4500	17,18
20	35,88	900	27,06	2000	22,42	5000	16,47
40	35,40	1000	26,49	2200	21,82	5500	15,83
60	34,97	1100	25,96	2400	21,28	6000	15,24
80	34,59	1200	25,47	2600	20,77	6500	14,69
100	34,24	1300	25,01	2800	20,29	7000	14,18
200	32,92	1400	24,57	3000	19,85	7500	13,71
300	31,92	1440	24,41	3200	19,43	8000	13,26
400	30,89	1500	24,16	3400	19,03	8500	12,85
500	29,95	1600	23,78	3600	18,66	9000	12,45
600	29,12	1700	23,41	3800	18,30	9500	12,07
700	28,37	1800	23,07	4000	17,96	10000	11,72

Tooth shear strength / rpm

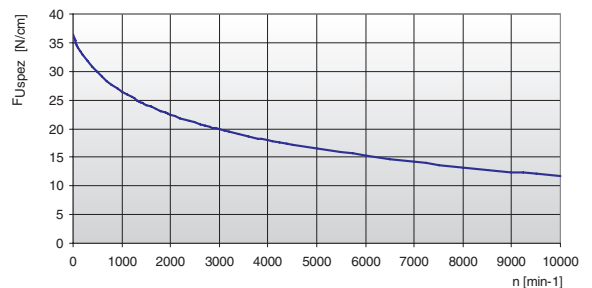

The specific load F_{Uspez} is the maximum load which one single belt tooth 1 cm wide can withstand in all operating conditions. This force is related to the drive rpm. The total load F_u transmissible by the belt in the drive is calculated by:

$$F_u [N] = F_{Uspez} \cdot Z_e \cdot b$$

- F_u [N] = peripheral force
- F_{Uspez} [N/cm] = specific load
- Z_e = number of teeth in mesh in the small pulley
- Z_{emax} = max. no of teeth in mesh to be considered for the calculation of the drive
- Z_{emax} = 12 for ELATECH® M
- Z_{emax} = 6 for ELATECH® V
- b [cm] = belt width in cm

AT 5

Specialties

Belt width b [mm]	ARAMID CORD		STAINLESS STEEL		HFE High Flexibility	
	F _{Tzul} [N] M type	F _{Br} [N]	F _{Tzul} [N] M type	F _{Br} [N]	F _{Tzul} [N] M type	F _{Br} [N]
10	880	3600	600	2400	960	3440
16	1540	6300	1050	4200	1680	6020
25	2530	10350	1725	6900	2760	9890
32	3300	13500	2250	9000	3600	12900
50	5280	21600	3600	14400	5760	20640
75	8030	32850	5475	21900	8760	31390
100	10780	44100	7350	29400	11760	42140

Flexibility

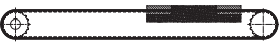
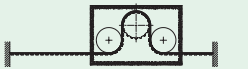
Minimum pulley number of teeth and minimum idler diameter		Type of cord			
		STANDARD	ARAMID	STAINLESS	HFE
Drive without reverse bending 	Timing pulley z _{min}	15	15	18	15
	Flat idler running on belt teeth d _{min}	30 mm	30 mm	40 mm	25 mm
Drive with reverse bending 	Timing pulley z _{min}	25	25	25	20
	Flat idler running on belt back d _{min}	60 mm	60 mm	65 mm	50 mm

Timing pulleys

z	da	dw	z	da	dw	z	da	dw	z	da	dw
15	22,65	23,88	45	70,40	71,64	75	118,15	119,40	105	165,90	167,16
16	24,20	25,47	46	72,00	73,23	76	119,75	120,99	106	167,50	168,75
17	25,80	27,06	47	73,55	74,82	77	121,35	122,58	107	169,10	170,34
18	27,40	28,65	48	75,15	76,42	78	122,90	124,18	108	170,70	171,94
19	29,00	30,25	49	76,75	78,01	79	124,50	125,77	109	172,25	173,53
20	30,60	31,83	50	78,35	79,60	80	126,10	127,36	110	173,85	175,12
21	32,20	33,43	51	79,95	81,19	81	127,70	128,95	111	175,45	176,71
22	33,80	35,02	52	81,55	82,78	82	129,30	130,54	112	177,05	178,30
23	35,40	36,62	53	83,10	84,38	83	130,90	132,14	113	178,65	179,84
24	37,00	38,21	54	84,70	85,97	84	132,45	133,73	114	180,25	181,49
25	38,60	39,80	55	86,30	87,54	85	134,05	135,32	115	181,85	183,08
26	40,20	41,39	56	87,90	89,15	86	135,65	136,91	116	183,45	184,67
27	41,80	42,98	57	89,50	90,74	87	137,25	138,50	117	185,00	186,26
28	43,35	44,58	58	91,10	92,34	88	138,85	140,10	118	186,60	187,86
29	44,95	46,17	59	92,65	93,93	89	140,45	141,69	119	188,20	189,45
30	46,55	47,76	60	94,25	95,52	90	142,05	143,28	120	189,80	191,04
31	48,15	49,35	61	95,85	97,11	91	143,60	144,87			
32	49,70	50,94	62	97,45	98,70	92	145,20	146,46			
33	51,30	52,54	63	99,05	100,30	93	146,80	148,06			
34	52,85	54,13	64	100,65	101,89	94	148,40	149,65			
35	54,45	55,72	65	102,25	103,48	95	150,00	151,24			
36	56,05	57,31	66	103,80	105,07	96	151,60	152,83			
37	57,65	58,90	67	105,40	106,66	97	153,15	154,42			
38	59,25	60,50	68	107,00	108,26	98	154,75	156,02			
39	60,85	62,09	69	108,60	109,85	99	156,35	157,61			
40	62,45	63,66	70	110,20	111,44	100	157,95	159,20			
41	64,00	65,27	71	111,80	113,03	101	159,55	160,79			
42	65,60	66,86	72	113,35	114,62	102	161,15	162,38			
43	67,30	68,46	73	114,95	116,22	103	162,70	163,97			
44	68,80	70,05	74	116,55	117,81	104	164,30	165,57			

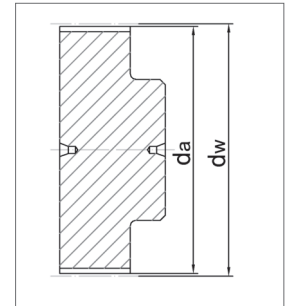

AT 10

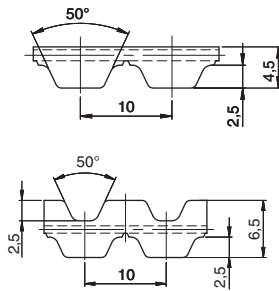

Belt characteristics

- Polyurethane timing belt with steel tension cords
- Tooth profile according to ISO 17396
- Metric pitch 10 mm
- Tooth profile and dimension are optimised to guarantee uniform load distribution and minimum deformation under load
- High resistance and low stretch steel cords to guarantee high stability and low elongation
- Reduced polygonal effect with reduced drive vibration
- Particularly suitable for linear drives and medium power transmission applications with high axial and angular positioning accuracy
- Double sided tooth construction available
- Negative length tolerance available on request

- Width tolerance: ±0,5 [mm]
- Length tolerance: ±0,5 [mm/m]
- Thickness tolerance: ±0,2 [mm]

Technical Data

Belt width b [mm]	Allowable tensile load Type M F _{Tzul} [N]	Allowable tensile load Type V F _{Tzul} [N]	Breaking load Type M F _{Br} [N]	Specific spring rate C _{spez} [N]	Weight [kg/m]
16	2450	1225	9500	612500	0,09
25	4170	2085	16150	1042500	0,15
32	5390	2695	20900	1347500	0,19
50	8580	4290	33250	2145000	0,30
75	12990	6495	50350	3247500	0,44
100	17400	8700	67450	4350000	0,59
150	26220	13110	101650	6555000	0,90

Other widths are available on request.

Load / Elongation [%]

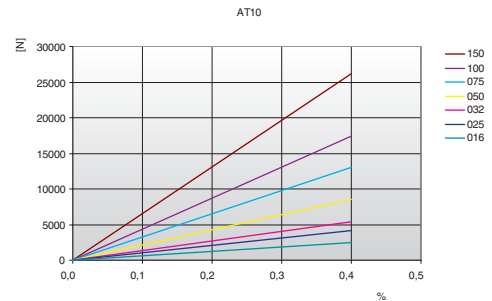

Tooth shear strength

rpm	F _{Uspez} [N/cm]	rpm	F _{Uspez} [N/cm]	rpm	F _{Uspez} [N/cm]	rpm	F _{Uspez} [N/cm]
0	88,57	800	62,83	1900	49,16	4500	34,08
20	87,06	900	61,09	2000	48,29	5000	32,17
40	85,66	1000	59,49	2200	46,67	5500	30,43
60	84,35	1100	58,02	2400	45,18	6000	28,84
80	83,13	1200	56,66	2600	43,80	6500	27,37
100	81,99	1300	55,39	2800	42,51	7000	26,01
200	77,36	1400	54,20	3000	41,30	7500	24,73
300	75,09	1440	53,74	3200	40,17	8000	23,53
400	71,99	1500	53,08	3400	39,09	8500	22,41
500	69,27	1600	52,02	3600	38,08	9000	21,34
600	66,88	1700	51,02	3800	37,11	9500	20,33
700	64,75	1800	50,06	4000	36,20	10000	19,37

Tooth shear strength / rpm

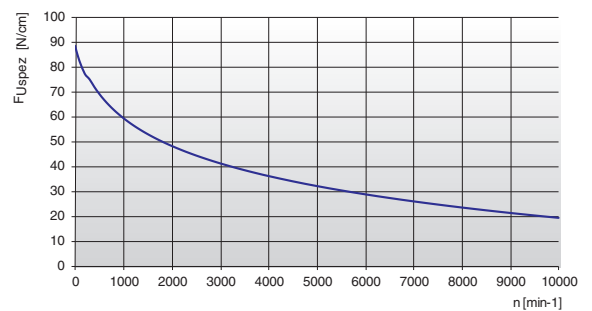

The specific load F_{Uspez} is the maximum load which one single belt tooth 1 cm wide can withstand in all operating conditions. This force is related to the drive rpm.

The total load F_u transmissible by the belt in the drive is calculated by:

$$F_u [N] = F_{Uspez} \cdot Z_e \cdot b$$

- F_u [N] = peripheral force
- F_{Uspez} [N/cm] = specific load
- Z_e = number of teeth in mesh in the small pulley
- Z_{e,max} = max. no of teeth in mesh to be considered for the calculation of the drive
- Z_{e,max} = 12 for ELATECH® M
- Z_{e,max} = 6 for ELATECH® V
- b [cm] = belt width in cm

AT 10

Specialties

Belt width b [mm]	ARAMID CORD		STAINLESS STEEL		HFE High Flexibility	
	F _{Tzul} [N] M type	F _{Br} [N]	F _{Tzul} [N] M type	F _{Br} [N]	F _{Tzul} [N] M type	F _{Br} [N]
16	2200	7900	1800	7500	2000	8500
25	3740	13430	3060	12750	3400	14450
32	4840	17380	3960	16500	4400	18700
50	7700	27650	6300	26250	7000	29750
75	11660	41870	9540	39750	-	-
100	15620	56090	12780	53250	-	-
150	23540	84530	-	-	-	-

Flexibility

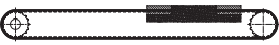
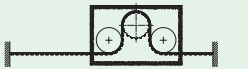
Minimum pulley number of teeth and minimum idler diameter		Type of cord			
		STANDARD	ARAMID	STAINLESS	HFE
Drive without reverse bending 	Timing pulley z _{min}	15	15	20	12
	Flat idler running on belt teeth d _{min}	50 mm	50 mm	70 mm	50 mm
Drive with reverse bending 	Timing pulley z _{min}	25	20	40	20
	Flat idler running on belt back d _{min}	120 mm	120 mm	120 mm	80 mm

Timing pulleys

z	da	dw	z	da	dw	z	da	dw	z	da	dw
15	45,70	47,75	45	141,40	143,24	75	236,90	238,72	105	332,35	334,21
16	49,05	50,93	46	144,55	146,42	76	240,05	241,94	106	335,55	337,40
17	52,25	54,11	47	147,75	149,60	77	243,25	245,09	107	338,75	340,58
18	55,45	57,29	48	150,95	152,78	78	246,40	248,24	108	341,90	343,76
19	58,60	60,48	49	154,10	155,97	79	249,60	251,46	109	345,10	346,95
20	61,80	63,66	50	157,30	159,15	80	252,80	254,64	110	348,30	350,13
21	65,00	66,84	51	160,50	162,33	81	255,95	257,82	111	351,45	353,31
22	68,15	70,03	52	163,65	165,52	82	259,15	261,00	112	354,65	356,50
23	71,35	73,20	53	166,85	168,70	83	262,30	264,19	113	357,80	359,68
24	74,55	76,39	54	170,05	171,88	84	265,50	267,37	114	361,00	362,86
25	77,70	79,58	55	173,20	175,06	85	268,70	270,52	115	364,19	366,04
26	80,90	82,76	56	176,40	178,25	86	271,90	273,74	116	367,39	369,23
27	84,10	85,95	57	179,60	181,43	87	275,05	276,92	117	370,56	372,41
28	87,25	89,12	58	182,75	184,61	88	278,25	280,10	118	373,74	375,59
29	90,45	92,21	59	185,95	187,80	89	281,45	283,28	119	376,93	378,78
30	93,65	95,49	60	189,10	190,98	90	284,60	286,47	120	380,11	381,96
31	96,80	98,67	61	192,30	194,16	91	287,80	289,65			
32	100,00	101,86	62	195,50	197,35	92	291,00	292,84			
33	103,20	105,04	63	198,65	200,53	93	294,20	296,02			
34	106,40	108,19	64	201,85	203,71	94	297,35	299,20			
35	109,55	111,41	65	205,05	206,90	95	300,55	302,39			
36	112,75	114,59	66	208,20	210,08	96	303,70	305,57			
37	115,90	117,77	67	211,40	213,26	97	306,90	308,75			
38	119,10	120,95	68	214,60	216,44	98	310,10	311,93			
39	122,30	124,14	69	217,75	219,63	99	313,25	315,12			
40	125,45	127,32	70	220,95	222,81	100	316,45	318,30			
41	128,65	130,50	71	224,15	225,99	101	319,65	321,48			
42	131,85	133,69	72	227,30	229,18	102	322,80	324,66			
43	135,00	136,87	73	230,50	232,33	103	326,00	327,85			
44	138,20	140,05	74	233,70	235,54	104	329,20	331,03			

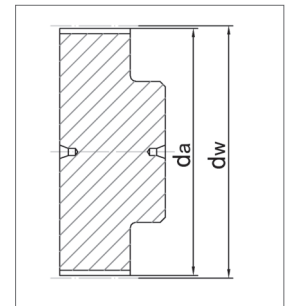

SAT 10

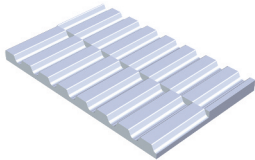
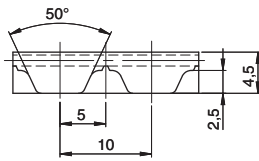

Belt characteristics

- Polyurethane timing belt with steel tension cords
- Metric pitch 10 mm
- Tooth profile and dimension are optimised to guarantee uniform load distribution and minimum deformation under load
- High resistance and low stretch steel cords to guarantee high stability and low elongation
- Reduced polygonal effect with reduced drive vibration
- Particularly suitable for linear drives and medium power transmission applications with high axial and angular positioning accuracy
- Negative length tolerance available on request

- Width tolerance: ±0,5 [mm]
- Length tolerance: ±0,5 [mm/m]
- Thickness tolerance: ±0,2 [mm]

Technical Data

Belt width b [mm]	Allowable tensile load Type M F _{Tzul} [N]	Allowable tensile load Type V F _{Tzul} [N]	Breaking load Type M F _{Br} [N]	Specific spring rate C _{spez} [N]	Weight [kg/m]
50	8330	4165	32300	2082500	0,29
75	12740	6370	49400	3185000	0,43
100	17150	8575	66500	4287500	0,57

Other widths are available on request.

Load / Elongation [%]

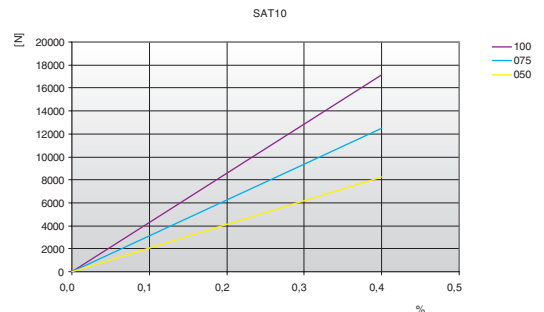

Tooth shear strength

rpm	F _{Uspez} [N/cm]	rpm	F _{Uspez} [N/cm]	rpm	F _{Uspez} [N/cm]	rpm	F _{Uspez} [N/cm]
0	88,57	800	62,83	1900	49,16	4500	34,08
20	87,06	900	61,09	2000	48,29	5000	32,17
40	85,66	1000	59,49	2200	46,67	5500	30,43
60	84,35	1100	58,02	2400	45,18	6000	28,84
80	83,13	1200	56,66	2600	43,80	6500	27,37
100	81,99	1300	55,39	2800	42,51	7000	26,01
200	77,36	1400	54,20	3000	41,30	7500	24,73
300	75,09	1440	53,74	3200	40,17	8000	23,53
400	71,99	1500	53,08	3400	39,09	8500	22,41
500	69,27	1600	52,02	3600	38,08	9000	21,34
600	66,88	1700	51,02	3800	37,11	9500	20,33
700	64,75	1800	50,06	4000	36,20	10000	19,37

Tooth shear strength / rpm

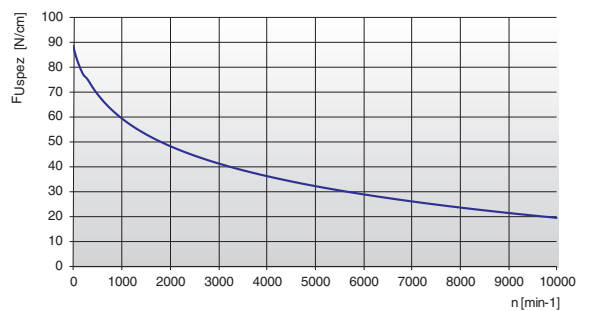

The specific load F_{Uspez} is the maximum load which one single belt tooth 1 cm wide can withstand in all operating conditions. This force is related to the drive rpm. The total load F_u transmissible by the belt in the drive is calculated by:

$$F_u [N] = F_{Uspez} \cdot Z_e \cdot b$$

- F_u [N] = peripheral force
- F_{Uspez} [N/cm] = specific load
- Z_e = number of teeth in mesh in the small pulley
- Z_{e,max} = max. no of teeth in mesh to be considered for the calculation of the drive
- Z_{e,max} = 12 for ELATECH® M
- Z_{e,max} = 6 for ELATECH® V
- b [cm] = belt width in cm

SAT 10

Specialties

Belt width b [mm]	STAINLESS STEEL		HFE High Flexibility	
	F _{Tzul} [N] M type	F _{Br} [N]	F _{Tzul} [N] M type	F _{Br} [N]
50	6300	26250	7000	29750

Flexibility

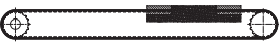
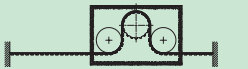
Minimum pulley number of teeth and minimum idler diameter		Type of cord			
		STANDARD	ARAMID	STAINLESS	HFE
Drive without reverse bending 	Timing pulley z _{min}	15	15	20	12
	Flat idler running on belt teeth d _{min}	50 mm	50 mm	70 mm	50 mm
Drive with reverse bending 	Timing pulley z _{min}	25	20	40	20
	Flat idler running on belt back d _{min}	120 mm	120 mm	120 mm	80 mm

Timing pulleys

z	da	dw	z	da	dw	z	da	dw	z	da	dw
15	45,70	47,75	45	141,40	143,24	75	236,90	238,72	105	332,35	334,21
16	49,05	50,93	46	144,55	146,42	76	240,05	241,94	106	335,55	337,40
17	52,25	54,11	47	147,75	149,60	77	243,25	245,09	107	338,75	340,58
18	55,45	57,29	48	150,95	152,78	78	246,40	248,24	108	341,90	343,76
19	58,60	60,48	49	154,10	155,97	79	249,60	251,46	109	345,10	346,95
20	61,80	63,66	50	157,30	159,15	80	252,80	254,64	110	348,30	350,13
21	65,00	66,84	51	160,50	162,33	81	255,95	257,82	111	351,45	353,31
22	68,15	70,03	52	163,65	165,52	82	259,15	261,00	112	354,65	356,50
23	71,35	73,20	53	166,85	168,70	83	262,30	264,19	113	357,80	359,68
24	74,55	76,39	54	170,05	171,88	84	265,50	267,37	114	361,00	362,86
25	77,70	79,58	55	173,20	175,06	85	268,70	270,52	115	364,19	366,04
26	80,90	82,76	56	176,40	178,25	86	271,90	273,74	116	367,39	369,23
27	84,10	85,95	57	179,60	181,43	87	275,05	276,92	117	370,56	372,41
28	87,25	89,12	58	182,75	184,61	88	278,25	280,10	118	373,74	375,59
29	90,45	92,21	59	185,95	187,80	89	281,45	283,28	119	376,93	378,78
30	93,65	95,49	60	189,10	190,98	90	284,60	286,47	120	380,11	381,96
31	96,80	98,67	61	192,30	194,16	91	287,80	289,65			
32	100,00	101,86	62	195,50	197,35	92	291,00	292,84			
33	103,20	105,04	63	198,65	200,53	93	294,20	296,02			
34	106,40	108,19	64	201,85	203,71	94	297,35	299,20			
35	109,55	111,41	65	205,05	206,90	95	300,55	302,39			
36	112,75	114,59	66	208,20	210,08	96	303,70	305,57			
37	115,90	117,77	67	211,40	213,26	97	306,90	308,75			
38	119,10	120,95	68	214,60	216,44	98	310,10	311,93			
39	122,30	124,14	69	217,75	219,63	99	313,25	315,12			
40	125,45	127,32	70	220,95	222,81	100	316,45	318,30			
41	128,65	130,50	71	224,15	225,99	101	319,65	321,48			
42	131,85	133,69	72	227,30	229,18	102	322,80	324,66			
43	135,00	136,87	73	230,50	232,33	103	326,00	327,85			
44	138,20	140,05	74	233,70	235,54	104	329,20	331,03			

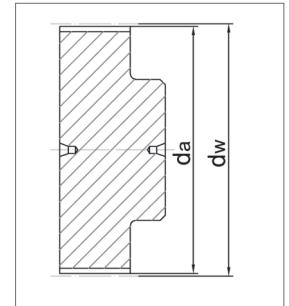

AT 20

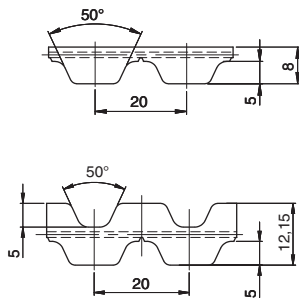

Belt characteristics

- Polyurethane timing belt with steel tension cords
- Tooth profile according to ISO 17396
- Metric pitch 20 mm
- Tooth profile and dimension are optimised to guarantee uniform load distribution and minimum deformation under load
- High resistance and low stretch steel cords to guarantee high stability and low elongation
- Reduced polygonal effect with reduced drive vibration
- Particularly suitable for linear drives and heavy power transmission applications with high axial and angular positioning accuracy
- Double sided tooth construction available

- Width tolerance: $\pm 1,0$ [mm]
- Length tolerance: $\pm 0,5$ [mm/m]
- Thickness tolerance: $\pm 0,4$ [mm]

Technical Data

Belt width b [mm]	Allowable tensile load Type M F_{Tzul} [N]	Allowable tensile load Type V F_{Tzul} [N]	Breaking load Type M F_{Br} [N]	Specific spring rate C_{spez} [N]	Weight [kg/m]
25	5280	2640	19250	1320000	0,24
32	7200	3600	26250	1800000	0,31
50	11520	5760	42000	2880000	0,48
75	17280	8640	63000	4320000	0,73
100	23520	11760	85750	5880000	0,97
150	35520	17760	129500	8880000	1,45

Other widths are available on request.

Load / Elongation [%]

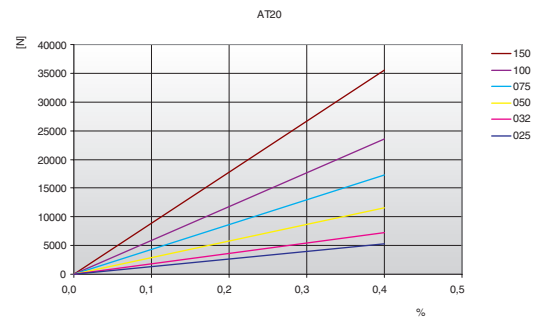

Tooth shear strength

rpm	F_{Uspez} [N/cm]	rpm	F_{Uspez} [N/cm]	rpm	F_{Uspez} [N/cm]	rpm	F_{Uspez} [N/cm]
0	151,40	800	97,44	1900	69,96	4500	39,72
20	148,56	900	93,93	2000	68,22	5000	35,90
40	145,89	1000	90,73	2200	64,97	5500	32,42
60	143,38	1100	87,77	2400	61,98	6000	29,23
80	141,01	1200	85,02	2600	59,20	6500	26,29
100	138,78	1300	82,47	2800	56,62	-	-
200	129,43	1400	80,07	3000	54,20	-	-
300	122,28	1440	79,16	3200	51,92	-	-
400	115,96	1500	77,82	3400	49,77	-	-
500	110,45	1600	75,70	3600	47,74	-	-
600	105,61	1700	73,69	3800	45,80	-	-
700	101,31	1800	71,77	4000	43,96	-	-

Tooth shear strength / rpm

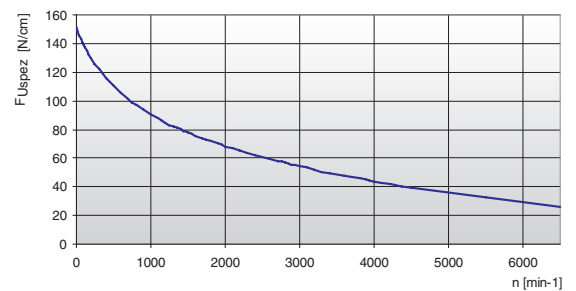

The specific load F_{Uspez} is the maximum load which one single belt tooth 1 cm wide can withstand in all operating conditions. This force is related to the drive rpm.

The total load F_u transmissible by the belt in the drive is calculated by:

$$F_u [N] = F_{Uspez} \cdot Z_e \cdot b$$

- F_u [N] = peripheral force
- F_{Uspez} [N/cm] = specific load
- Z_e = number of teeth in mesh in the small pulley
- Z_{emax} = max. no of teeth in mesh to be considered for the calculation of the drive
- Z_{emax} = 12 for ELATECH® M
- Z_{emax} = 6 for ELATECH® V
- b [cm] = belt width in cm

AT 20**Specialties**

Belt width b [mm]	HFE High Flexibility		KEVLAR®		INOX	
	F _{Tzul} [N] M type	F _{Br} [N]	F _{Tzul} [N] M type	F _{Br} [N]	F _{Tzul} [N] M type	F _{Br} [N]
25	5060	21175	2420	11000	3300	15400
32	6900	28875	3300	15000	4500	21000
50	11040	46200	5280	24000	7200	33600
75	16560	69300	7920	36000	10800	50400
100	22540	94325	10780	49000	14700	68600

Flexibility

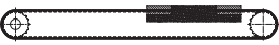
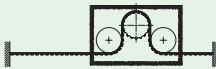
Minimum pulley number of teeth and minimum idler diameter		Type of cord			
		STANDARD	HFE	KEVLAR®	INOX
Drive without reverse bending 	Timing pulley z _{min}	18	18	18	20
	Flat idler running on belt teeth d _{min}	120 mm	120 mm	120 mm	125 mm
Drive with reverse bending 	Timing pulley z _{min}	25	25	25	30
	Flat idler running on belt back d _{min}	180 mm	150 mm	160 mm	200 mm

Timing pulleys

z	da	dw	z	da	dw	z	da	dw	z	da	dw
18	111,75	114,59	48	302,70	305,58	78	493,70	496,56	108	684,70	687,54
19	118,10	120,95	49	309,10	311,93	79	500,05	502,91	109	691,05	693,89
20	124,50	127,32	50	315,45	318,30	80	506,45	509,28	110	697,40	700,26
21	130,75	133,69	51	321,80	324,67	81	512,80	515,65	111	703,80	706,63
22	137,20	140,05	52	328,20	331,03	82	519,15	522,02	112	710,15	712,99
23	143,55	146,42	53	334,55	337,40	83	525,55	528,39	113	716,50	719,36
24	149,95	152,78	54	340,90	343,76	84	531,90	534,74	114	722,90	725,72
25	156,30	159,15	55	347,30	350,13	85	538,25	541,11	115	729,24	732,09
26	162,65	165,52	56	353,65	356,50	86	544,60	547,48	116	735,61	738,46
27	169,05	171,88	57	360,00	362,86	87	551,00	553,85	117	741,96	744,83
28	175,40	178,25	58	366,40	369,23	88	557,35	560,22	118	748,34	751,19
29	181,75	184,62	59	372,75	375,59	89	563,70	566,57	119	754,70	757,56
30	188,15	190,99	60	379,10	381,96	90	570,10	572,94	120	761,07	763,93
31	194,50	197,35	61	385,45	388,33	91	576,45	579,31			
32	200,85	203,72	62	391,85	394,69	92	582,85	585,67			
33	207,20	210,09	63	398,20	401,06	93	589,20	592,04			
34	213,60	216,44	64	404,55	407,43	94	595,55	598,40			
35	219,95	222,81	65	410,95	413,79	95	601,90	604,77			
36	226,35	229,18	66	417,30	420,16	96	608,30	611,14			
37	232,70	235,54	67	423,65	426,52	97	614,65	617,50			
38	239,05	241,91	68	430,05	432,89	98	621,00	623,87			
39	245,45	248,27	69	436,40	439,26	99	627,35	630,24			
40	251,80	254,64	70	442,80	445,63	100	633,75	636,60			
41	258,15	261,01	71	449,15	451,99	101	640,10	642,97			
42	264,50	267,37	72	455,50	458,36	102	646,50	649,34			
43	270,90	273,74	73	461,85	464,73	103	652,85	655,71			
44	277,25	280,10	74	468,25	471,08	104	659,20	662,06			
45	283,60	286,47	75	474,60	477,45	105	665,60	668,43			
46	290,00	292,84	76	480,95	483,82	106	671,95	674,80			
47	296,35	299,21	77	487,35	490,19	107	678,30	681,17			

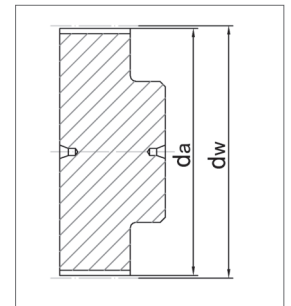

ATL 5

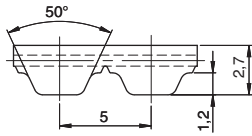

Belt characteristics

- High performance polyurethane timing belt with HPL steel tension cords
- Metric pitch 5 mm
- Specially designed for linear drives
- Tension cords with increased allowable tensile load compared to standard for lower elongation
- Produced with special pretension and pitch tolerance to guarantee high positioning precision in linear drives
- Negative length tolerance available on request

- Width tolerance: $\pm 0,5$ [mm]
- Thickness tolerance: $\pm 0,2$ [mm]

Technical Data

Belt width b [mm]	Allowable tensile load Type M F_{Tzul} [N]	Breaking load Type M F_{Br} [N]	Specific spring rate C_{spez} [N]	Weight [kg/m]
10	920	3360	230000	0,04
16	1610	5880	402500	0,06
25	2650	9660	662500	0,10
32	3450	12600	862500	0,12
50	5520	20160	1380000	0,19
75	8400	30660	2100000	0,29
100	11270	41160	2817500	0,38

Other widths are available on request.

Load / Elongation [%]

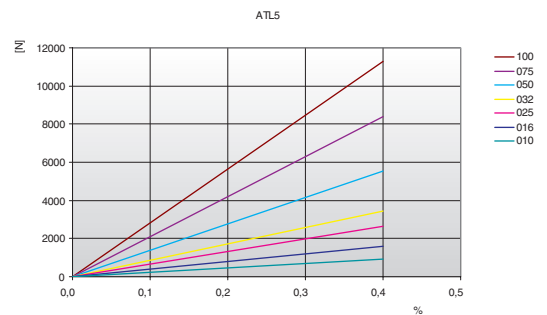

Tooth shear strength

rpm	F_{Uspez} [N/cm]	rpm	F_{Uspez} [N/cm]	rpm	F_{Uspez} [N/cm]	rpm	F_{Uspez} [N/cm]
0	36,40	800	27,69	1900	22,73	4500	17,18
20	35,88	900	27,06	2000	22,42	5000	16,47
40	35,40	1000	26,49	2200	21,82	5500	15,83
60	34,97	1100	25,96	2400	21,28	6000	15,24
80	34,59	1200	25,47	2600	20,77	6500	14,69
100	34,24	1300	25,01	2800	20,29	7000	14,18
200	32,92	1400	24,57	3000	19,85	7500	13,71
300	31,92	1440	24,41	3200	19,43	8000	13,26
400	30,89	1500	24,16	3400	19,03	8500	12,85
500	29,95	1600	23,78	3600	18,66	9000	12,45
600	29,12	1700	23,41	3800	18,30	9500	12,07
700	28,37	1800	23,07	4000	17,96	10000	11,72

Tooth shear strength / rpm

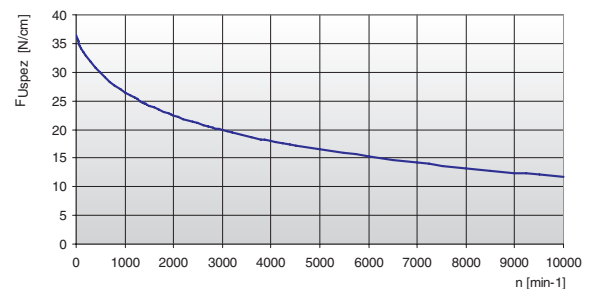

The specific load F_{Uspez} is the maximum load which one single belt tooth 1 cm wide can withstand in all operating conditions.

This force is related to the drive rpm.

The total load F_u transmissible by the belt in the drive is calculated by:

$$F_u [N] = F_{Uspez} \cdot z_e \cdot b$$

- F_u [N] = peripheral force
- F_{Uspez} [N/cm] = specific load
- z_e = number of teeth in mesh in the small pulley
- z_{emax} = max. no of teeth in mesh to be considered for the calculation of the drive
- z_{emax} = 12 for ELATECH® M
- z_{emax} = 6 for ELATECH® V
- b [cm] = belt width in cm

ATL 5

Flexibility

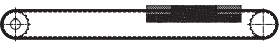
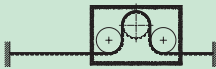
Minimum pulley number of teeth and minimum idler diameter		Type of cord
		STANDARD
Drive without reverse bending 	Timing pulley z_{min}	25
	Flat idler running on belt teeth d_{min}	40 mm
Drive with reverse bending 	Timing pulley z_{min}	25
	Flat idler running on belt back d_{min}	60 mm

Timing pulleys

z	da	dw	z	da	dw	z	da	dw	z	da	dw
15	22,65	23,88	45	70,40	71,64	75	118,15	119,40	105	165,90	167,16
16	24,20	25,47	46	72,00	73,23	76	119,75	120,99	106	167,50	168,75
17	25,80	27,06	47	73,55	74,82	77	121,35	122,58	107	169,10	170,34
18	27,40	28,65	48	75,15	76,42	78	122,90	124,18	108	170,70	171,94
19	29,00	30,25	49	76,75	78,01	79	124,50	125,77	109	172,25	173,53
20	30,60	31,83	50	78,35	79,60	80	126,10	127,36	110	173,85	175,12
21	32,20	33,43	51	79,95	81,19	81	127,70	128,95	111	175,45	176,71
22	33,80	35,02	52	81,55	82,78	82	129,30	130,54	112	177,05	178,30
23	35,40	36,62	53	83,10	84,38	83	130,90	132,14	113	178,65	179,84
24	37,00	38,21	54	84,70	85,97	84	132,45	133,73	114	180,25	181,49
25	38,60	39,80	55	86,30	87,54	85	134,05	135,32	115	181,85	183,08
26	40,20	41,39	56	87,90	89,15	86	135,65	136,91	116	183,45	184,67
27	41,80	42,98	57	89,50	90,74	87	137,25	138,50	117	185,00	186,26
28	43,35	44,58	58	91,10	92,34	88	138,85	140,10	118	186,60	187,86
29	44,95	46,17	59	92,65	93,93	89	140,45	141,69	119	188,20	189,45
30	46,55	47,76	60	94,25	95,52	90	142,05	143,28	120	189,80	191,04
31	48,15	49,35	61	95,85	97,11	91	143,60	144,87			
32	49,70	50,94	62	97,45	98,70	92	145,20	146,46			
33	51,30	52,54	63	99,05	100,30	93	146,80	148,06			
34	52,85	54,13	64	100,65	101,89	94	148,40	149,65			
35	54,45	55,72	65	102,25	103,48	95	150,00	151,24			
36	56,05	57,31	66	103,80	105,07	96	151,60	152,83			
37	57,65	58,90	67	105,40	106,66	97	153,15	154,42			
38	59,25	60,50	68	107,00	108,26	98	154,75	156,02			
39	60,85	62,09	69	108,60	109,85	99	156,35	157,61			
40	62,45	63,66	70	110,20	111,44	100	157,95	159,20			
41	64,00	65,27	71	111,80	113,03	101	159,55	160,79			
42	65,60	66,86	72	113,35	114,62	102	161,15	162,38			
43	67,30	68,46	73	114,95	116,22	103	162,70	163,97			
44	68,80	70,05	74	116,55	117,81	104	164,30	165,57			

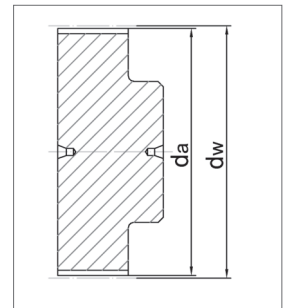

ATL 10

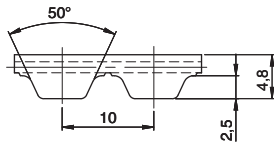

Belt characteristics

- High performance polyurethane timing belt with HPL steel tension cords
- Metric pitch 10 mm
- Specially designed for linear drives
- Tension cords with increased allowable tensile load compared to standard for lower elongation
- Produced with special pretension and pitch tolerance to guarantee high positioning precision in linear drives
- Negative length tolerance available on request

- Width tolerance: $\pm 0,5$ [mm]
- Thickness tolerance: $\pm 0,2$ [mm]

Technical Data

Belt width b [mm]	Allowable tensile load Type M F_{Tzul} [N]	Breaking load Type M F_{Br} [N]	Specific spring rate C_{spez} [N]	Weight [kg/m]
16	3840	14000	960000	0,11
25	6720	24500	1680000	0,17
32	8640	31500	2160000	0,22
50	14400	52500	3600000	0,35
75	21600	78750	5400000	0,52
100	29280	106750	7320000	0,69
150	44160	161000	11040000	0,85

Other widths are available on request.

Load / Elongation [%]

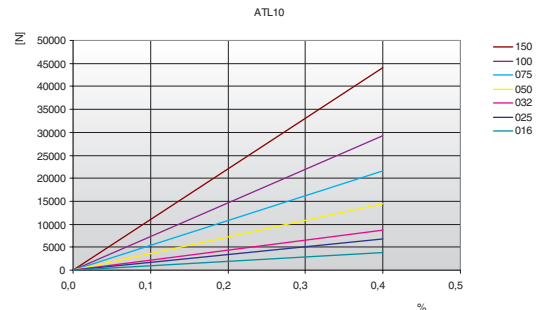

Tooth shear strength

rpm	F_{Uspez} [N/cm]	rpm	F_{Uspez} [N/cm]	rpm	F_{Uspez} [N/cm]	rpm	F_{Uspez} [N/cm]
0	88,57	800	62,83	1900	49,16	4500	34,08
20	87,06	900	61,09	2000	48,29	5000	32,17
40	85,66	1000	59,49	2200	46,67	5500	30,43
60	84,35	1100	58,02	2400	45,18	6000	28,84
80	83,13	1200	56,66	2600	43,80	6500	27,37
100	81,99	1300	55,39	2800	42,51	7000	26,01
200	77,36	1400	54,20	3000	41,30	7500	24,73
300	75,09	1440	53,74	3200	40,17	8000	23,53
400	71,99	1500	53,08	3400	39,09	8500	22,41
500	69,27	1600	52,02	3600	38,08	9000	21,34
600	66,88	1700	51,02	3800	37,11	9500	20,33
700	64,75	1800	50,06	4000	36,20	10000	19,37

Tooth shear strength / rpm

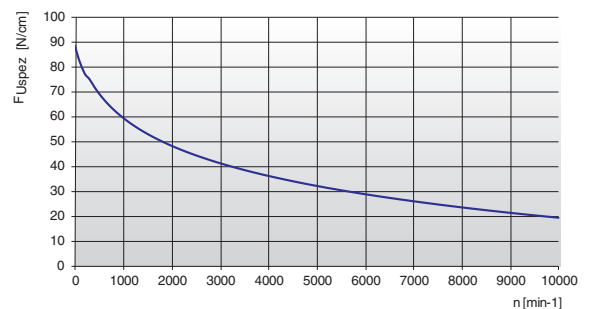

The specific load F_{Uspez} is the maximum load which one single belt tooth 1 cm wide can withstand in all operating conditions.

This force is related to the drive rpm.

The total load F_u transmissible by the belt in the drive is calculated by:

$$F_u [N] = F_{Uspez} \cdot z_e \cdot b$$



- F_u [N] = peripheral force
- F_{Uspez} [N/cm] = specific load
- z_e = number of teeth in mesh in the small pulley
- z_{emax} = max. no of teeth in mesh to be considered for the calculation of the drive
- z_{emax} = 12 for ELATECH® M
- z_{emax} = 6 for ELATECH® V
- b [cm] = belt width in cm

ATL 10

Specialties

Belt width b [mm]	HFE High Flexibility		INOX	
	F_{Tzul} [N] M type	F_{Br} [N]	F_{Tzul} [N] M type	F_{Br} [N]
16	3680	15400	2400	11200
25	6440	26950	4200	19600
32	8280	34650	5400	25200
50	13800	57750	9000	42000
75	20700	86625	13500	63000
100	28060	117425	18300	85400
150	42320	177100	27600	128800

Flexibility

Minimum pulley number of teeth and minimum idler diameter		Type of cord		
		STANDARD	HFE	INOX
Drive without reverse bending 	Timing pulley Z_{min}	25	20	32
	Flat idler running on belt teeth d_{min}	80 mm	60 mm	100 mm
Drive with reverse bending 	Timing pulley Z_{min}	25	20	40
	Flat idler running on belt back d_{min}	150 mm	100 mm	250 mm

Timing pulleys

z	da	dw	z	da	dw	z	da	dw	z	da	dw
18	55,45	57,29	48	150,95	152,78	78	246,40	248,24	108	341,90	343,76
19	58,60	60,48	49	154,10	155,97	79	249,60	251,46	109	345,10	346,95
20	61,80	63,66	50	157,30	159,15	80	252,80	254,64	110	348,30	350,13
21	65,00	66,84	51	160,50	162,33	81	255,95	257,82	111	351,45	353,31
22	68,15	70,03	52	163,65	165,52	82	259,15	261,00	112	354,65	356,50
23	71,35	73,20	53	166,85	168,70	83	262,30	264,19	113	357,80	359,68
24	74,55	76,39	54	170,05	171,88	84	265,50	267,37	114	361,00	362,86
25	77,70	79,58	55	173,20	175,06	85	268,70	270,52	115	364,19	366,04
26	80,90	82,76	56	176,40	178,25	86	271,90	273,74	116	367,39	369,23
27	84,10	85,95	57	179,60	181,43	87	275,05	276,92	117	370,56	372,41
28	87,25	89,12	58	182,75	184,61	88	278,25	280,10	118	373,74	375,59
29	90,45	92,21	59	185,95	187,80	89	281,45	283,28	119	376,93	378,78
30	93,65	95,49	60	189,10	190,98	90	284,60	286,47	120	380,11	381,96
31	96,80	98,67	61	192,30	194,16	91	287,80	289,65			
32	100,00	101,86	62	195,50	197,35	92	291,00	292,84			
33	103,20	105,04	63	198,65	200,53	93	294,20	296,02			
34	106,40	108,19	64	201,85	203,71	94	297,35	299,20			
35	109,55	111,41	65	205,05	206,90	95	300,55	302,39			
36	112,75	114,59	66	208,20	210,08	96	303,70	305,57			
37	115,90	117,77	67	211,40	213,26	97	306,90	308,75			
38	119,10	120,95	68	214,60	216,44	98	310,10	311,93			
39	122,30	124,14	69	217,75	219,63	99	313,25	315,12			
40	125,45	127,32	70	220,95	222,81	100	316,45	318,30			
41	128,65	130,50	71	224,15	225,99	101	319,65	321,48			
42	131,85	133,69	72	227,30	229,18	102	322,80	324,66			
43	135,00	136,87	73	230,50	232,33	103	326,00	327,85			
44	138,20	140,05	74	233,70	235,54	104	329,20	331,03			
45	141,40	143,24	75	236,90	238,72	105	332,35	334,21			
46	144,55	146,42	76	240,05	241,94	106	335,55	337,40			
47	147,75	149,60	77	243,25	245,09	107	338,75	340,58			

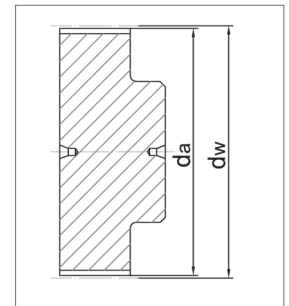

ATL 20

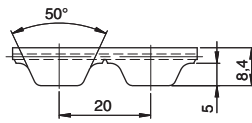

Belt characteristics

- High performance polyurethane timing belt with HPL steel tension cords
- Metric pitch 20 mm
- Specially designed for linear drives
- Tension cords with increased allowable tensile load compared to standard for lower elongation
- Produced with special pretension and pitch tolerance to guarantee high positioning precision in linear drives

- Width tolerance: $\pm 1,0$ [mm]
- Thickness tolerance: $\pm 0,4$ [mm]

Technical Data

Belt width b [mm]	Allowable tensile load Type M F_{Tzul} [N]	Breaking load Type M F_{Br} [N]	Specific spring rate C_{spez} [N]	Weight [kg/m]
25	7650	28800	1912500	0,28
32	10200	38400	2550000	0,36
50	16150	60800	4037500	0,56
75	24650	92800	6162500	0,84
100	33150	124800	8287500	1,12
150	51000	192000	12750000	1,68
200	68000	256000	17000000	2,25

Other widths are available on request.

Load / Elongation [%]

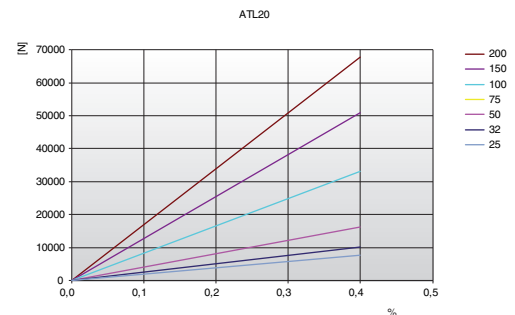

Tooth shear strength

rpm	F_{Uspez} [N/cm]	rpm	F_{Uspez} [N/cm]	rpm	F_{Uspez} [N/cm]	rpm	F_{Uspez} [N/cm]
0	151,40	800	97,44	1900	69,96	4500	39,72
20	148,56	900	93,93	2000	68,22	5000	35,90
40	145,89	1000	90,73	2200	64,97	5500	32,42
60	143,38	1100	87,77	2400	61,98	6000	29,23
80	141,01	1200	85,02	2600	59,20	6500	26,29
100	138,78	1300	82,47	2800	56,62	-	-
200	129,43	1400	80,07	3000	54,20	-	-
300	122,28	1440	79,16	3200	51,92	-	-
400	115,96	1500	77,82	3400	49,77	-	-
500	110,45	1600	75,70	3600	47,74	-	-
600	105,61	1700	73,69	3800	45,80	-	-
700	101,31	1800	71,77	4000	43,96	-	-

Tooth shear strength / rpm

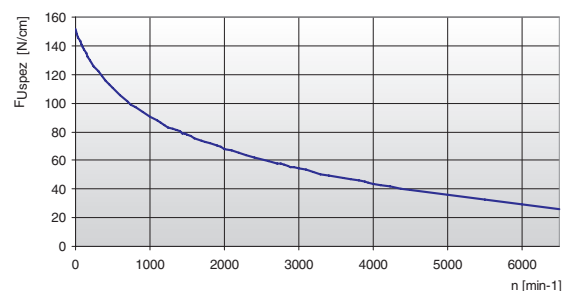

The specific load F_{Uspez} is the maximum load which one single belt tooth 1 cm wide can withstand in all operating conditions. This force is related to the drive rpm.

The total load F_u transmissible by the belt in the drive is calculated by:

$$F_u [N] = F_{Uspez} \cdot Z_e \cdot b$$

- $F_u [N]$ = peripheral force
- $F_{Uspez} [N/cm]$ = specific load
- Z_e = number of teeth in mesh in the small pulley
- Z_{emax} = max. no of teeth in mesh to be considered for the calculation of the drive
- Z_{emax} = 12 for ELATECH® M
- Z_{emax} = 6 for ELATECH® V
- $b [cm]$ = belt width in cm

ATL 20

Specialties

Belt width b [mm]	INOX	
	F _{Tzul} [N] M type	F _{Br} [N]
25	5220	20700
32	6960	27600
50	11020	43700
75	16820	66700
100	22620	89700

Flexibility

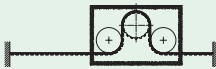
Minimum pulley number of teeth and minimum idler diameter		Type of cord	
		STANDARD	INOX
Drive without reverse bending 	Timing pulley z _{min}	25	32
	Flat idler running on belt teeth d _{min}	160 mm	200 mm
Drive with reverse bending 	Timing pulley z _{min}	25	40
	Flat idler running on belt back d _{min}	250 mm	250 mm

Timing pulleys

z	da	dw	z	da	dw	z	da	dw	z	da	dw
18	111,75	114,59	480	302,70	305,58	78	493,70	496,56	108	684,70	687,54
19	118,10	120,95	49	309,10	311,93	79	500,05	502,91	109	691,05	693,89
20	124,50	127,32	50	315,45	318,30	80	506,45	509,28	110	697,40	700,26
21	130,75	133,69	51	321,80	324,67	81	512,80	515,65	111	703,80	706,63
22	137,20	140,05	52	328,20	331,03	82	519,15	522,02	112	710,15	712,99
23	143,55	146,42	53	334,55	337,40	83	525,55	528,39	113	716,50	719,36
24	149,95	152,78	54	340,90	343,76	84	531,90	534,74	114	722,90	725,72
25	156,30	159,15	55	347,30	350,13	85	538,25	541,11	115	729,24	732,09
26	162,65	165,52	56	353,65	356,50	86	544,60	547,48	116	735,61	738,46
27	169,05	171,88	57	360,00	362,86	87	551,00	553,85	117	741,96	744,83
28	175,40	178,25	58	366,40	369,23	88	557,35	560,22	118	748,34	751,19
29	181,75	184,62	59	372,75	375,59	89	563,70	566,57	119	754,70	757,56
30	188,15	190,99	60	379,10	381,96	90	570,10	572,94	120	761,07	763,93
31	194,50	197,35	61	385,45	388,33	91	576,45	579,31			
32	200,85	203,72	62	391,85	394,69	92	582,85	585,67			
33	207,20	210,09	63	398,20	401,06	93	589,20	592,04			
34	213,60	216,44	64	404,55	407,43	94	595,55	598,40			
35	219,95	222,81	65	410,95	413,79	95	601,90	604,77			
36	226,35	229,18	66	417,30	420,16	96	608,30	611,14			
37	232,70	235,54	67	423,65	426,52	97	614,65	617,50			
38	239,05	241,91	68	430,05	432,89	98	621,00	623,87			
39	245,45	248,27	69	436,40	439,26	99	627,35	630,24			
40	251,80	254,64	70	442,80	445,63	100	633,75	636,60			
41	258,15	261,01	71	449,15	451,99	101	640,10	642,97			
42	264,50	267,37	72	455,50	458,36	102	646,50	649,34			
43	270,90	273,74	73	461,85	464,73	103	652,85	655,71			
44	277,25	280,10	74	468,25	471,08	104	659,20	662,06			
45	283,60	286,47	75	474,60	477,45	105	665,60	668,43			
46	290,00	292,84	76	480,95	483,82	106	671,95	674,80			
47	296,35	299,21	77	487,35	490,19	107	678,30	681,17			

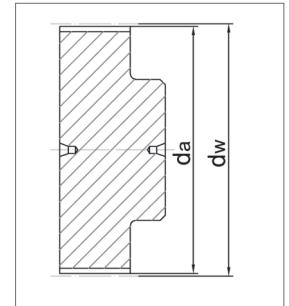

MXL

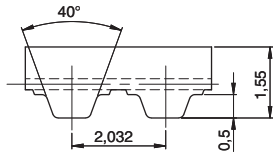

Belt characteristics

- Polyurethane timing belt with tooth profile according to UNI/ISO 5296 with steel tension cords
- Imperial pitch 2/25" = 2,032 mm
- Allow to use small diameter pulley
- Mainly used in applications where inch pitch is an advantage (USA / UK)
- Trasparent (natural) PU colour

- Width tolerance: ±0,5 [mm]
- Length tolerance: ±0,8 [mm/m]
- Thickness tolerance: ±0,1 [mm]

Technical Data

Belt width b Code / mm	Allowable tensile load Type M F _{Tzul} [N]	Allowable tensile load Type V F _{Tzul} [N]	Breaking load Type M F _{Br} [N]	Specific spring rate C _{spez} [N]	Weight [kg/m]
025 / 6,35	220	110	875	55000	0,014
050 / 12,7	450	225	1750	112500	0,025
100 / 25,4	900	450	3500	225000	0,050
200 / 50,8	1790	895	7000	447500	0,095
400 / 101,6	3580	1790	14000	895000	0,190

Other widths are available on request.

Load / Elongation [%]

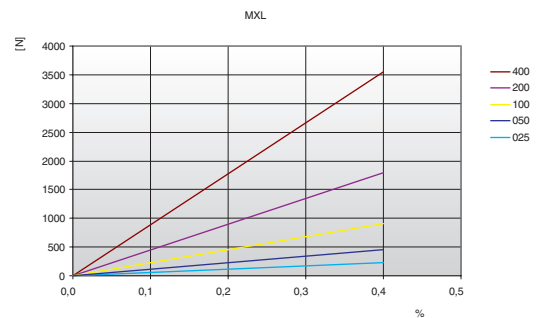

Tooth shear strength

rpm	F _{Uspez} [N/cm]	rpm	F _{Uspez} [N/cm]	rpm	F _{Uspez} [N/cm]	rpm	F _{Uspez} [N/cm]
0	7,58	800	4,99	1900	4,21	4500	3,41
20	7,31	900	4,88	2000	4,16	5000	3,31
40	7,09	1000	4,79	2200	4,07	5500	3,22
60	6,92	1100	4,70	2400	3,99	6000	3,14
80	6,78	1200	4,62	2600	3,92	6500	3,06
100	6,67	1300	4,55	2800	3,85	7000	2,99
200	6,15	1400	4,48	3000	3,78	7500	2,93
300	5,83	1440	4,46	3200	3,72	8000	2,86
400	5,59	1500	4,42	3400	3,67	8500	2,81
500	5,40	1600	4,36	3600	3,61	9000	2,75
600	5,24	1700	4,31	3800	3,56	9500	2,70
700	5,11	1800	4,25	4000	3,52	10000	2,65

Tooth shear strength / rpm

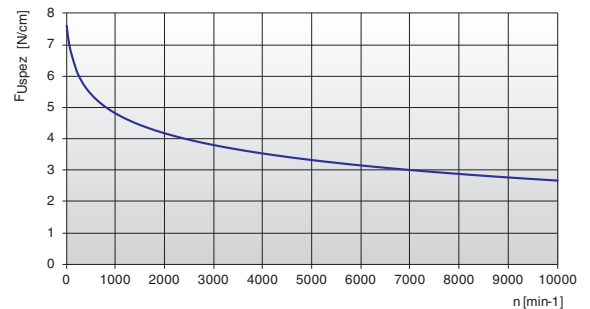

The specific load F_{Uspez} is the maximum load which one single belt tooth 1 cm wide can withstand in all operating conditions. This force is related to the drive rpm. The total load F_u transmissible by the belt in the drive is calculated by:

$$F_u [N] = F_{Uspez} \cdot Z_e \cdot b$$

- F_u [N] = peripheral force
- F_{Uspez} [N/cm] = specific load
- Z_e = number of teeth in mesh in the small pulley
- Z_{e,max} = max. no of teeth in mesh to be considered for the calculation of the drive
- Z_{e,max} = 12 for ELATECH® M
- Z_{e,max} = 6 for ELATECH® V
- b [cm] = belt width in cm

MXL

Flexibility

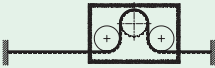
Minimum pulley number of teeth and minimum idler diameter		Type of cord
		STANDARD
 <p>Drive without reverse bending</p>	Timing pulley z_{min}	12
	Flat idler running on belt teeth d_{min}	20 mm
 <p>Drive with reverse bending</p>	Timing pulley z_{min}	15
	Flat idler running on belt back d_{min}	25 mm

Timing pulleys

z	da	dw	z	da	dw	z	da	dw	z	da	dw
10	5,96	6,47	44	27,95	28,46	78	49,94	50,45	112	71,93	72,44
11	6,61	7,12	45	28,60	29,11	79	50,59	51,10	113	72,58	73,09
12	7,25	7,76	46	29,24	29,75	80	51,23	51,74	114	73,23	73,74
13	7,90	8,41	47	29,89	30,40	81	51,88	52,39	115	73,87	74,38
14	8,55	9,06	48	30,54	31,05	82	52,53	53,04	116	74,52	75,03
15	9,19	9,70	49	31,18	31,69	83	53,17	53,68	117	75,17	75,68
16	9,84	10,35	50	31,83	32,34	84	53,82	54,33	118	75,81	76,32
17	10,49	11,00	51	32,48	32,99	85	54,47	54,98	119	76,46	76,97
18	11,13	11,64	52	33,12	33,63	86	55,12	55,63	120	77,11	77,62
19	11,78	12,29	53	33,77	34,28	87	55,76	56,27	121	77,75	78,26
20	12,43	12,94	54	34,42	34,93	88	56,41	56,92	122	78,40	78,91
21	13,07	13,58	55	35,06	35,57	89	57,06	57,57	123	79,05	79,56
22	13,72	14,23	56	35,71	36,22	90	57,70	58,21	124	79,69	80,20
23	14,37	14,88	57	36,36	36,87	91	58,36	58,86	125	80,34	80,85
24	15,01	15,52	58	37,00	37,51	92	59,00	59,51	126	80,99	81,50
25	15,66	16,17	59	37,65	38,16	93	59,64	60,15	127	81,63	82,14
26	16,31	16,82	60	38,30	38,81	94	60,29	60,80	128	82,28	82,79
27	16,95	17,46	61	38,95	39,46	95	60,94	61,45	129	82,93	83,44
28	17,60	18,11	62	39,59	40,10	96	61,58	62,09	130	83,57	84,08
29	18,25	18,76	63	40,24	40,75	97	62,23	62,74	131	84,22	84,73
30	18,89	19,40	64	40,89	41,40	98	62,88	63,39	132	84,87	85,38
31	19,54	20,05	65	41,53	42,04	99	63,52	64,03	133	85,51	86,02
32	20,19	20,70	66	42,18	42,69	100	64,17	64,68	134	86,16	86,67
33	20,83	21,34	67	42,83	43,34	101	64,82	65,33	135	86,81	87,32
34	21,48	21,99	68	43,47	43,98	102	65,46	65,97	136	87,46	87,97
35	22,13	22,64	69	44,12	44,63	103	66,11	66,62	137	88,10	88,61
36	22,78	23,29	70	44,77	45,28	104	66,76	67,27	138	88,75	89,26
37	23,42	23,93	71	45,41	45,92	105	67,40	67,91	139	89,40	89,91
38	24,07	24,58	72	46,06	46,57	106	68,05	68,56	140	90,04	90,55
39	24,72	25,23	73	46,71	47,22	107	68,70	69,21			
40	25,36	25,87	74	47,35	47,86	108	69,34	69,85			
41	26,01	26,52	75	48,00	48,51	109	69,99	70,50			
42	26,66	27,17	76	48,65	49,16	110	70,64	71,15			
43	27,30	27,81	77	49,29	49,80	111	71,29	71,80			

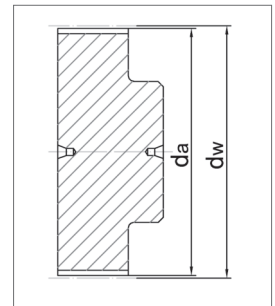

XL

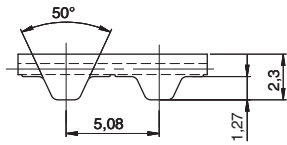

Belt characteristics

- Polyurethane timing belt with tooth profile according to UNI/ISO 5296 with steel tension cords
- Imperial pitch 1/5" = 5,08 mm
- Allow to use small diameter pulley
- Mainly used in applications where inch pitch is an advantage (USA / UK)

- Width tolerance: ±0,5 [mm]
- Length tolerance: ±0,5 [mm/m]
- Thickness tolerance: ±0,2 [mm]

Technical Data

Belt width b Code / mm	Allowable tensile load Type M F _{Tzul} [N]	Allowable tensile load Type V F _{Tzul} [N]	Breaking load Type M F _{Br} [N]	Specific spring rate C _{spez} [N]	Weight [kg/m]
025 / 6,35	190	95	750	47500	0,015
031 / 7,94	260	130	1000	65000	0,019
037 / 9,53	290	145	1125	72500	0,023
050 / 12,7	420	210	1625	105000	0,031
075 / 19,1	670	335	2625	167500	0,046
100 / 25,4	900	450	3500	225000	0,061
150 / 38,1	1410	705	5500	352500	0,092
200 / 50,8	1890	945	7375	472500	0,122
400 / 101,6	3840	1920	15000	960000	0,244

Other widths are available on request.

Tooth shear strength

rpm	F _{Uspez} [N/cm]	rpm	F _{Uspez} [N/cm]	rpm	F _{Uspez} [N/cm]	rpm	F _{Uspez} [N/cm]
0	25,10	800	17,32	1900	14,46	4500	11,45
20	24,46	900	16,94	2000	14,28	5000	11,08
40	23,90	1000	16,60	2200	13,96	5500	10,74
60	23,42	1100	16,29	2400	13,66	6000	10,43
80	23,00	1200	16,01	2600	13,38	6500	10,14
100	22,63	1300	15,74	2800	13,12	7000	9,87
200	21,24	1400	15,49	3000	12,88	7500	9,63
300	20,22	1440	15,40	3200	12,65	8000	9,39
400	19,42	1500	15,26	3400	12,44	8500	9,17
500	18,77	1600	15,04	3600	12,24	9000	8,97
600	18,22	1700	14,84	3800	12,05	9500	8,77
700	17,74	1800	14,64	4000	11,87	10000	8,59

The specific load F_{Uspez} is the maximum load which one single belt tooth 1 cm wide can withstand in all operating conditions. This force is related to the drive rpm.

The total load F_u transmissible by the belt in the drive is calculated by:

$$F_u [N] = F_{Uspez} \cdot z_e \cdot b$$

- F_u [N] = peripheral force
- F_{Uspez} [N/cm] = specific load
- z_e = number of teeth in mesh in the small pulley
- z_{emax} = max. no of teeth in mesh to be considered for the calculation of the drive
- z_{emax} = 12 for ELATECH® M
- z_{emax} = 6 for ELATECH® V
- b [cm] = belt width in cm

Load / Elongation [%]

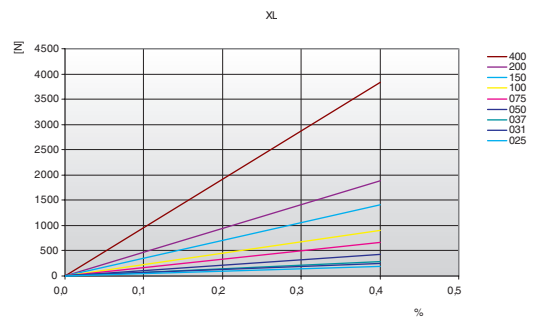

Tooth shear strength / rpm

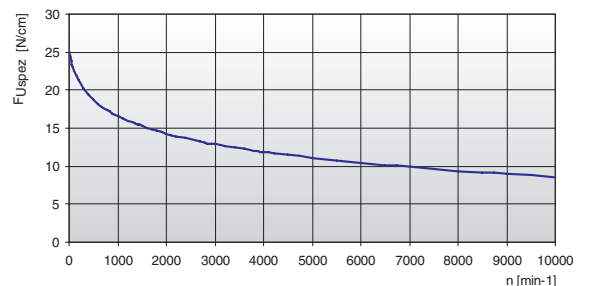



XL

Specialties

Belt width b	ARAMID CORD	
	F _{Tzul} [N] M type	F _{Br} [N]
025 / 6,35	420	1680
031 / 7,94	560	1230
037 / 9,53	630	2520
050 / 12,7	910	3640
075 / 19,1	1470	5880
100 / 25,4	1960	7840
150 / 38,1	3080	12320
200 / 50,8	4130	16520
400 / 101,6	8400	33600

Flexibility

Minimum pulley number of teeth and minimum idler diameter		Type of cord	
		STANDARD	ARAMID
 Drive without reverse bending	Timing pulley z _{min}	10	10
	Flat idler running on belt teeth d _{min}	30 mm	30 mm
 Drive with reverse bending	Timing pulley z _{min}	15	15
	Flat idler running on belt back d _{min}	30 mm	30 mm

Timing pulleys

z	da	dw	z	da	dw	z	da	dw	z	da	dw
10	15,66	16,17	40	64,17	64,68	70	112,68	113,19	100	161,19	161,70
11	17,28	17,79	41	65,79	66,30	71	114,30	114,81	101	162,81	163,32
12	18,89	19,40	42	67,40	67,91	72	115,92	116,43	102	164,42	164,93
13	20,51	21,02	43	69,02	69,53	73	117,53	118,04	103	166,04	166,55
14	22,13	22,64	44	70,64	71,15	74	119,15	119,66	104	167,66	168,17
15	23,74	24,25	45	72,26	72,77	75	120,77	121,28	105	169,28	169,79
16	25,36	25,87	46	73,87	74,38	76	122,38	122,89	106	170,89	171,40
17	26,98	27,49	47	75,49	76,00	77	124,00	124,51	107	172,51	173,02
18	28,60	29,11	48	77,11	77,62	78	125,62	126,13	108	174,13	174,64
19	30,21	30,72	49	78,72	79,23	79	127,23	127,74	109	175,74	176,25
20	31,83	32,34	50	80,34	80,85	80	128,85	129,36	110	177,36	177,87
21	33,45	33,96	51	81,96	82,47	81	130,47	130,98	111	178,98	179,49
22	35,06	35,57	52	83,57	84,08	82	132,08	132,59	112	180,59	181,10
23	36,68	37,19	53	85,19	85,70	83	133,70	134,21	113	182,21	182,72
24	38,30	38,81	54	86,81	87,32	84	135,32	135,83	114	183,83	184,34
25	39,92	40,43	55	88,42	88,93	85	136,93	137,44	115	185,44	185,95
26	41,53	42,04	56	90,04	90,55	86	138,55	139,06	116	187,06	187,57
27	43,15	43,66	57	91,66	92,17	87	140,17	140,68	117	188,68	189,19
28	44,77	45,28	58	93,28	93,79	88	141,75	142,30	118	190,30	190,81
29	46,38	46,89	59	94,89	95,40	89	143,36	143,91	119	191,91	192,42
30	48,00	48,51	60	96,51	97,02	90	145,02	145,53	120	193,53	194,04
31	49,62	50,13	61	98,13	98,64	91	146,64	147,15			
32	51,23	51,74	62	99,74	100,25	92	148,25	148,76			
33	52,85	53,36	63	101,36	101,87	93	149,87	150,38			
34	54,47	54,98	64	102,98	103,49	94	151,49	152,00			
35	56,09	56,60	65	104,60	105,11	95	153,11	153,62			
36	57,70	58,21	66	106,21	106,72	96	154,72	155,23			
37	59,32	59,83	67	107,83	108,34	97	156,34	156,85			
38	60,94	61,45	68	109,45	109,96	98	157,96	158,47			
39	62,55	63,06	69	111,06	111,57	99	159,57	160,08			

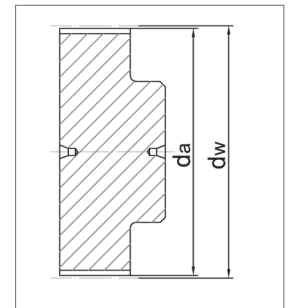



L

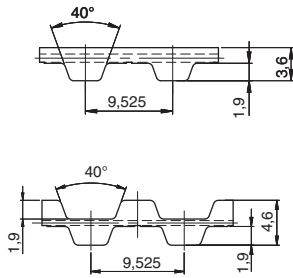

Belt characteristics

- Polyurethane timing belt with tooth profile according to UNI/ISO 5296 with steel tension cords
- Imperial pitch $3/8" = 9,525$ mm
- Allow to use small diameter pulley
- Mainly used in applications where inch pitch is an advantage (USA / UK)

- Width tolerance: $\pm 0,5$ [mm]
- Length tolerance: $\pm 0,5$ [mm/m]
- Thickness tolerance: $\pm 0,2$ [mm]

Technical Data

Belt width b Code / mm	Allowable tensile load Type M F_{Tzul} [N]	Allowable tensile load Type V F_{Tzul} [N]	Breaking load Type M F_{Br} [N]	Specific spring rate C_{spez} [N]	Weight [kg/m]
050 / 12,7	1270	635	4620	317500	0,049
075 / 19,1	1960	980	7140	490000	0,073
100 / 25,4	2760	1380	10080	690000	0,098
150 / 38,1	4260	2130	15540	1065000	0,146
200 / 50,8	5640	2820	20580	1410000	0,195
300 / 76,2	8510	4255	31080	2127500	0,293
400 / 101,6	11390	5695	41580	2847500	0,390

Other widths are available on request.

Load / Elongation [%]

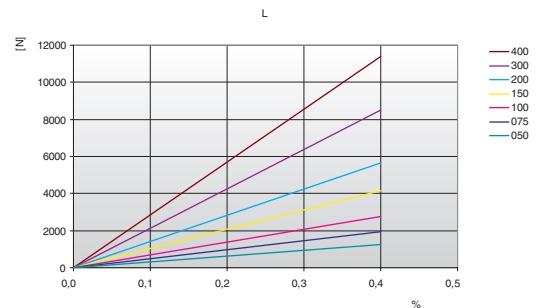

Tooth shear strength

rpm	F_{Uspez} [N/cm]	rpm	F_{Uspez} [N/cm]	rpm	F_{Uspez} [N/cm]	rpm	F_{Uspez} [N/cm]
0	38,6	800	24,7	1900	19,66	4500	14,36
20	37,42	900	24,04	2000	19,35	5000	13,7
40	36,4	1000	23,44	2200	18,77	5500	13,1
60	35,51	1100	22,89	2400	18,24	6000	12,55
80	34,74	1200	22,38	2600	17,76	6500	12,05
100	34,07	1300	21,91	2800	17,3	7000	11,58
200	31,59	1400	21,48	3000	16,88	7500	11,14
300	29,79	1440	21,31	3200	16,48	8000	10,73
400	28,39	1500	21,07	3400	16,1	8500	10,35
500	27,25	1600	20,69	3600	15,75	9000	9,98
600	26,28	1700	20,33	3800	15,41	9500	9,64
700	25,44	1800	19,98	4000	15,09	10000	9,31

Tooth shear strength / rpm

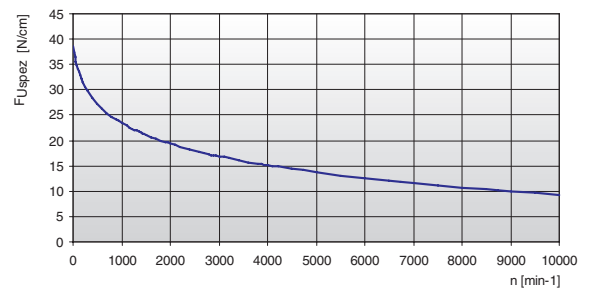

The specific load F_{Uspez} is the maximum load which one single belt tooth 1 cm wide can withstand in all operating conditions.

This force is related to the drive rpm.

The total load F_u transmissible by the belt in the drive is calculated by:

$$F_u [N] = F_{Uspez} \cdot Z_e \cdot b$$

- F_u [N] = peripheral force
- F_{Uspez} [N/cm] = specific load
- Z_e = number of teeth in mesh in the small pulley
- Z_{emax} = max. no of teeth in mesh to be considered for the calculation of the drive
- Z_{emax} = 12 for ELATECH® M
- Z_{emax} = 6 for ELATECH® V
- b [cm] = belt width in cm

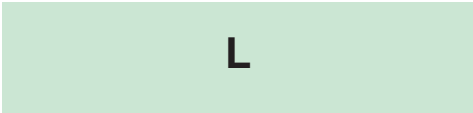

Specialties

Belt width b Code / mm	ARAMID CORD		STAINLESS STEEL	
	F _{Tzul} [N] M type	F _{Br} [N]	F _{Tzul} [N] M type	F _{Br} [N]
050 / 12,7	1210	4950	830	3300
075 / 19,1	1870	7650	1280	5100
100 / 25,4	2640	10800	1800	7200
150 / 38,1	4080	16700	2700	10800
200 / 50,8	5390	22050	3680	14700
300 / 76,2	8140	33300	-	-
400 / 101,6	10890	44550	-	-

Flexibility

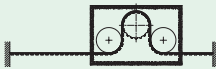
Minimum pulley number of teeth and minimum idler diameter		Type of cord		
		STANDARD	ARAMID	STAINLESS
Drive without reverse bending 	Timing pulley z _{min}	15	15	18
	Flat idler running on belt teeth d _{min}	60 mm	60 mm	65 mm
Drive with reverse bending 	Timing pulley z _{min}	20	20	20
	Flat idler running on belt back d _{min}	60 mm	60 mm	65 mm

Timing pulleys

z	da	dw	z	da	dw	z	da	dw	z	da	dw
10	29,56	30,32	40	120,52	121,27	70	211,47	212,23	100	302,43	303,18
11	32,59	33,35	41	123,55	124,30	71	214,50	215,26	101	305,46	306,21
12	35,62	36,38	42	126,58	127,33	72	217,53	218,29	102	308,49	309,24
13	38,65	39,41	43	129,61	130,36	73	220,56	221,32	103	311,52	312,29
14	41,68	42,44	44	132,64	133,39	74	223,59	224,35	104	314,55	315,32
15	44,71	45,47	45	135,67	136,44	75	226,62	227,38	105	317,58	318,35
16	47,74	48,50	46	138,70	139,47	76	229,65	230,41	106	320,61	321,38
17	50,77	51,53	47	141,73	142,50	77	232,70	233,46	107	323,64	324,41
18	53,80	54,56	48	144,76	145,53	78	235,73	236,49	108	326,69	327,44
19	56,83	57,61	49	147,80	148,56	79	238,76	239,52	109	329,72	330,47
20	59,88	60,64	50	150,83	151,59	80	241,79	242,55	110	332,75	333,50
21	62,91	63,67	51	153,86	154,62	81	244,82	245,58	111	335,78	336,53
22	65,94	66,70	52	156,89	157,65	82	247,85	248,61	112	338,81	339,56
23	68,97	69,73	53	159,92	160,68	83	250,88	251,64	113	341,84	342,61
24	72,00	72,76	54	162,95	163,71	84	253,91	254,67	114	344,87	345,64
25	75,03	75,80	55	166,00	166,76	85	256,94	257,70	115	347,90	348,67
26	78,06	78,83	56	169,03	169,79	86	259,97	260,73	116	350,93	351,70
27	81,09	81,86	57	172,06	172,82	87	263,02	263,78	117	353,96	354,73
28	84,12	84,89	58	175,09	175,85	88	266,05	266,81	118	357,00	357,76
29	87,15	87,92	59	178,12	178,88	89	269,08	269,84	119	360,03	360,79
30	90,20	90,95	60	181,15	181,91	90	272,11	272,87	120	363,07	363,82
31	93,23	93,98	61	184,18	184,94	91	275,14	275,90			
32	96,26	97,01	62	187,21	187,97	92	278,17	278,93			
33	99,29	100,04	63	190,24	191,00	93	281,20	281,96			
34	102,32	103,07	64	193,27	194,03	94	284,23	285,00			
35	105,35	106,12	65	196,30	197,06	95	287,26	288,03			
36	108,38	109,15	66	199,33	200,11	96	290,30	291,06			
37	111,41	112,18	67	202,38	203,14	97	293,33	294,09			
38	114,44	115,21	68	205,41	206,17	98	296,36	297,12			
39	117,47	118,24	69	208,44	209,20	99	299,40	300,15			

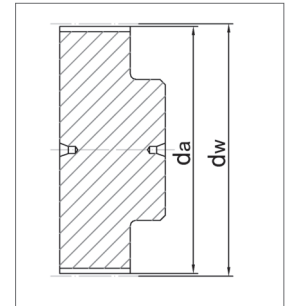

H

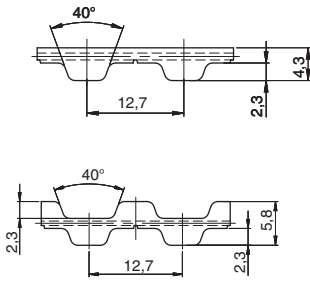

Belt characteristics

- Polyurethane timing belt with tooth profile according to UNI/ISO 5296 with steel tension cords
- Imperial pitch 1/2" = 12,7 mm
- Allow to use small diameter pulley
- Mainly used in applications where inch pitch is an advantage (USA / UK)

- Width tolerance: ±0,5 [mm]
- Length tolerance: ±0,5 [mm/m]
- Thickness tolerance: ±0,2 [mm]

Technical Data

Belt width b Code / mm	Allowable tensile load Type M F _{Tzul} [N]	Allowable tensile load Type V F _{Tzul} [N]	Breaking load Type M F _{Br} [N]	Specific spring rate C _{spez} [N]	Weight [kg/m]
050 / 12,7	1270	635	4620	317500	0,05
075 / 19,1	1960	980	7140	490000	0,08
100 / 25,4	2760	1380	10080	690000	0,11
150 / 38,1	4260	2130	15540	1065000	0,16
200 / 50,8	5640	2820	20580	1410000	0,22
300 / 76,2	8510	4255	31080	2127500	0,32
400 / 101,6	11390	5695	41580	2847500	0,43
600 / 152,4	17370	8685	63420	4342500	0,56
800 / 203,2*	11390	5695	41580	2847500	0,65

Other widths are available on request. * = double cords spacing

Load / Elongation [%]

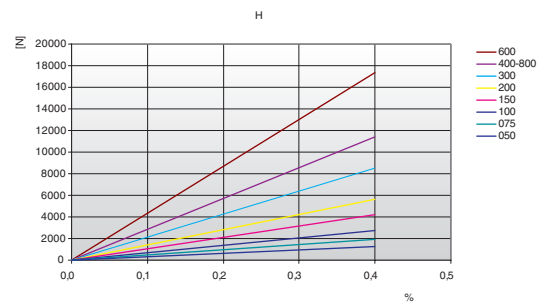

Tooth shear strength

rpm	F _{Uspez} [N/cm]	rpm	F _{Uspez} [N/cm]	rpm	F _{Uspez} [N/cm]	rpm	F _{Uspez} [N/cm]
0	45,30	800	29,04	1900	23,11	4500	16,88
20	43,95	900	28,26	2000	22,74	5000	16,11
40	42,78	1000	27,55	2200	22,07	5500	15,41
60	41,77	1100	26,90	2400	21,44	6000	14,76
80	40,88	1200	26,31	2600	20,87	6500	14,17
100	40,11	1300	25,76	2800	20,34	7000	13,62
200	37,22	1400	25,25	3000	19,84	7500	13,11
300	35,07	1440	25,05	3200	19,37	8000	12,63
400	33,41	1500	24,77	3400	18,93	8500	12,18
500	32,05	1600	24,32	3600	18,51	9000	11,75
600	30,90	1700	23,89	3800	18,12	9500	11,35
700	29,91	1800	23,49	4000	17,75	10000	10,96

Tooth shear strength / rpm

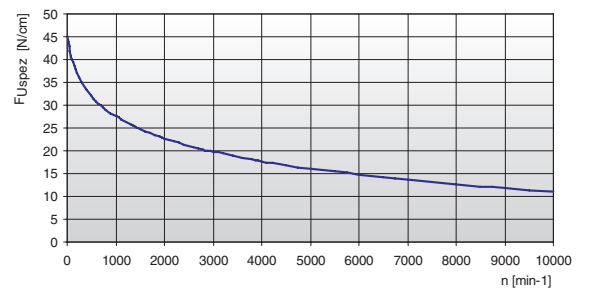

The specific load F_{Uspez} is the maximum load which one single belt tooth 1 cm wide can withstand in all operating conditions. This force is related to the drive rpm. The total load F_u transmissible by the belt in the drive is calculated by:

$$F_u [N] = F_{Uspez} \cdot Z_e \cdot b$$

- F_u [N] = peripheral force
- F_{Uspez} [N/cm] = specific load
- Z_e = number of teeth in mesh in the small pulley
- Z_{emax} = max. no of teeth in mesh to be considered for the calculation of the drive
- Z_{emax} = 12 for ELATECH® M
- Z_{emax} = 6 for ELATECH® V
- b [cm] = belt width in cm

H

Specialties

Belt width b Code / mm	ARAMID CORD		STAINLESS STEEL	
	F _{Tzul} [N] M type	F _{Br} [N]	F _{Tzul} [N] M type	F _{Br} [N]
050 / 12,7	1210	4950	830	3300
075 / 19,1	1870	7650	1280	5100
100 / 25,4	2640	10800	1800	7200
150 / 38,1	4100	16700	2700	10800
200 / 50,8	5390	22050	3680	14700
300 / 76,2	8140	33300	-	-
400 / 101,6	10890	44550	-	-
600 / 152,4	16500	67500	-	-
800 / 203,2*	11000	45000	-	-

*= double cords spacing

Flexibility

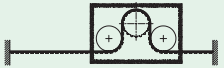
Minimum pulley number of teeth and minimum idler diameter		Type of cord		
		STANDARD	ARAMID	STAINLESS
Drive without reverse bending 	Timing pulley z _{min}	14	14	20
	Flat idler running on belt teeth d _{min}	60 mm	60 mm	80 mm
Drive with reverse bending 	Timing pulley z _{min}	20	20	40
	Flat idler running on belt back d _{min}	80 mm	80 mm	100 mm

Timing pulleys

z	da	dw	z	da	dw	z	da	dw	z	da	dw
14	55,23	56,60	44	176,50	177,86	74	297,78	299,14	104	419,04	420,42
15	59,27	60,64	45	180,54	181,90	75	301,82	303,18	105	423,08	424,46
16	63,31	64,68	46	184,58	185,96	76	305,86	307,22	106	427,14	428,50
17	67,35	68,72	47	188,62	190,00	77	309,90	311,26	107	431,18	432,54
18	71,40	72,76	48	192,67	194,04	78	313,94	315,32	108	435,22	436,58
19	75,44	76,80	49	196,71	198,08	79	317,98	319,36	109	439,26	440,62
20	79,48	80,84	50	200,75	202,13	80	322,02	323,40	110	443,30	444,68
21	83,52	84,88	51	204,80	206,17	81	326,06	327,44	111	447,34	448,72
22	87,57	88,94	52	208,84	210,21	82	330,12	331,48	112	451,38	452,76
23	91,61	92,98	53	212,88	214,25	83	334,16	335,52	113	455,42	456,80
24	95,65	97,02	54	216,92	218,29	84	338,20	339,56	114	459,48	460,84
25	99,69	101,06	55	220,96	222,33	85	342,24	343,60	115	463,52	464,88
26	103,73	105,10	56	225,00	226,37	86	346,28	347,66	116	467,56	468,92
27	107,77	109,14	57	229,04	230,41	87	350,33	351,70	117	471,60	472,96
28	111,81	113,18	58	233,10	234,47	88	354,37	355,74	118	475,64	477,02
29	115,85	117,22	59	237,14	238,51	89	358,41	359,78	119	479,68	481,06
30	119,91	121,28	60	241,18	242,55	90	362,45	363,82	120	483,72	485,10
31	123,95	125,32	61	245,22	246,59	91	366,50	367,86			
32	127,99	129,36	62	249,26	250,63	92	370,54	371,90			
33	132,03	133,40	63	253,30	254,67	93	374,58	375,94			
34	136,07	137,44	64	257,34	258,71	94	378,62	380,00			
35	140,11	141,48	65	261,38	262,75	95	382,66	384,04			
36	144,15	145,52	66	265,44	266,81	96	386,70	388,08			
37	148,20	149,56	67	269,48	270,85	97	390,74	392,12			
38	152,24	153,62	68	273,52	274,89	98	394,80	396,16			
39	156,28	157,66	69	277,56	278,93	99	398,84	400,20			
40	160,32	161,70	70	281,60	282,97	100	402,88	404,24			
41	164,36	165,74	71	285,64	287,01	101	406,92	408,28			
42	168,42	169,78	72	289,68	291,05	102	410,96	412,34			
43	172,46	173,82	73	293,72	295,10	103	415,00	416,38			

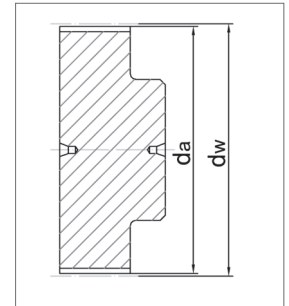

XH

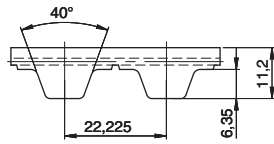

Belt characteristics

- Polyurethane timing belt with tooth profile according to UNI/ISO 5296 with steel tension cords
- Imperial pitch $7/8'' = 22,225$ mm
- Mainly used in applications where inch pitch is an advantage (USA / UK)

- Width tolerance: $\pm 1,0$ [mm]
- Length tolerance: $\pm 0,5$ [mm/m]
- Thickness tolerance: $\pm 0,4$ [mm]

Technical Data

Belt width b Code / mm	Allowable tensile load Type M F_{Tzul} [N]	Allowable tensile load Type V F_{Tzul} [N]	Breaking load Type M F_{Br} [N]	Specific spring rate C_{spez} [N]	Weight [kg/m]
100 / 25,4	3920	1960	15200	980000	0,370
200 / 50,8	8330	4165	32300	2082500	0,660
300 / 76,2	12740	6370	49400	3185000	0,990
400 / 101,6	17150	8575	66500	4287500	1,330
600 / 152,4	25970	12985	100700	6492500	1,990

Other widths are available on request.

Load / Elongation [%]

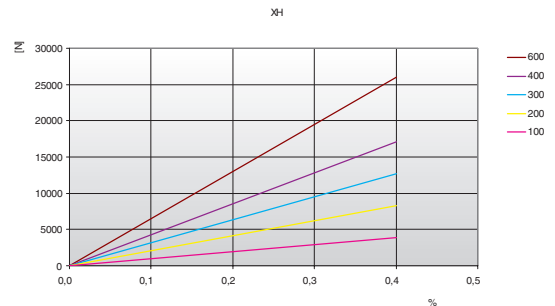

Tooth shear strength

rpm	F_{Uspez} [N/cm]	rpm	F_{Uspez} [N/cm]	rpm	F_{Uspez} [N/cm]	rpm	F_{Uspez} [N/cm]
0	96,00	800	55,99	1900	43,86	4000	33,31
20	92,98	900	54,35	2000	43,14	-	-
40	90,27	1000	52,88	2200	41,79	-	-
60	87,85	1100	51,55	2400	40,56	-	-
80	85,68	1200	50,33	2600	39,43	-	-
100	83,73	1300	49,20	2800	38,37	-	-
200	74,80	1400	48,16	2880	37,98	-	-
300	69,42	1440	47,77	3000	37,40	-	-
400	65,53	1500	47,19	3200	36,48	-	-
500	62,48	1600	46,29	3400	35,62	-	-
600	59,97	1700	45,43	3600	34,81	-	-
700	57,84	1800	44,62	3800	34,04	-	-

Tooth shear strength / rpm

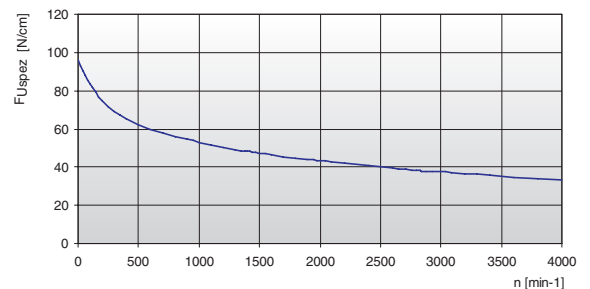

The specific load F_{Uspez} is the maximum load which one single belt tooth 1 cm wide can withstand in all operating conditions.

This force is related to the drive rpm.

The total load F_u transmissible by the belt in the drive is calculated by:

$$F_u [N] = F_{Uspez} \cdot Z_e \cdot b$$

- F_u [N] = peripheral force
- F_{Uspez} [N/cm] = specific load
- Z_e = number of teeth in mesh in the small pulley
- Z_{emax} = max. no of teeth in mesh to be considered for the calculation of the drive
- Z_{emax} = 12 for ELATECH® M
- Z_{emax} = 6 for ELATECH® V
- b [cm] = belt width in cm

XH

Specialties

Belt width b Code / mm	ARAMID CORD		STAINLESS STEEL	
	F _{Tzul} [N] M type	F _{Br} [N]	F _{Tzul} [N] M type	F _{Br} [N]
100 / 25,4	3520	16000	2880	12000
200 / 50,8	7480	34000	6120	25500
300 / 76,2	11440	52000	9360	39000
400 / 101,6	15400	70000	12600	52500
600 / 152,4	23320	106000	-	-

Flexibility

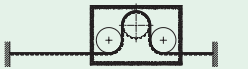
Minimum pulley number of teeth and minimum idler diameter		Type of cord		
		STANDARD	ARAMID	STAINLESS
Drive without reverse bending 	Timing pulley z _{min}	18	18	24
	Flat idler running on belt teeth d _{min}	150 mm	150 mm	160 mm
Drive with reverse bending 	Timing pulley z _{min}	20	20	30
	Flat idler running on belt back d _{min}	180 mm	180 mm	200 mm

Timing pulleys

z	da	dw	z	da	dw	z	da	dw	z	da	dw
18	127,34	124,55	48	339,57	336,77	78	551,79	549,00	108	764,03	761,22
19	134,41	131,62	49	346,66	343,87	79	558,88	556,07	109	771,10	768,30
20	141,48	138,68	50	353,73	350,93	80	565,95	563,15	110	778,17	775,37
21	148,55	145,76	51	360,80	358,00	81	573,02	570,22	111	785,26	782,44
22	155,64	152,84	52	367,87	365,07	82	580,09	577,29	112	792,33	789,51
23	162,71	159,91	53	374,94	372,14	83	587,18	584,36	113	799,40	796,60
24	169,78	167,00	54	382,01	379,21	84	594,25	591,43	114	806,47	803,67
25	176,85	174,07	55	389,08	386,30	85	601,32	598,60	115	813,54	810,74
26	183,94	181,13	56	396,17	393,37	86	608,39	605,61	116	820,63	817,81
27	191,01	188,20	57	403,24	400,44	87	615,46	612,68	117	827,70	824,88
28	198,08	195,27	58	410,31	407,51	88	622,55	619,75	118	834,77	831,95
29	205,15	202,37	59	417,38	414,58	89	629,62	626,82	119	841,84	839,03
30	212,22	209,44	60	424,47	421,68	90	636,69	633,89	120	848,93	846,12
31	219,31	216,51	61	431,54	428,75	91	643,76	640,96			
32	226,38	223,58	62	438,61	435,90	92	650,85	648,04			
33	233,45	230,66	63	445,68	442,90	93	657,92	655,11			
34	240,52	237,73	64	452,75	449,97	94	664,99	662,18			
35	247,59	244,80	65	459,84	457,05	95	672,06	669,25			
36	254,68	251,87	66	466,91	464,10	96	679,13	676,33			
37	261,75	258,94	67	473,98	471,20	97	686,22	683,40			
38	268,82	266,02	68	481,05	478,25	98	693,29	690,47			
39	275,89	273,11	69	488,12	485,32	99	700,36	697,55			
40	282,98	280,18	70	495,21	492,39	100	707,43	704,62			
41	290,05	287,25	71	502,28	499,48	101	714,50	711,70			
42	297,12	294,33	72	509,35	506,57	102	721,59	718,77			
43	304,19	301,40	73	516,42	513,63	103	728,66	725,85			
44	311,26	308,47	74	523,51	520,70	104	735,73	732,92			
45	318,35	315,54	75	530,58	527,77	105	742,80	740,01			
46	325,42	322,61	76	537,65	534,84	106	749,87	747,08			
47	332,49	329,70	77	544,72	541,93	107	756,96	754,15			

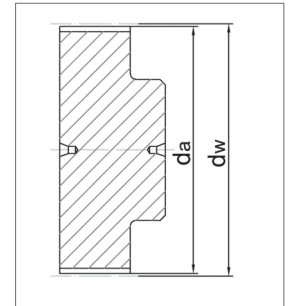

HTD 3M

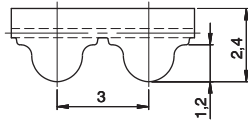

Belt characteristics

- Polyurethane timing belt with round tooth profile and high tensile load tension cords.
- Tooth profile according to ISO 13050
- Metric pitch 3 mm
- The round tooth profile allows a uniform load distribution that guarantees high performances, high transmissible torque and precise tooth engagement
- Widely used in linear positioning, light power transmission applications

- Width tolerance: $\pm 0,5$ [mm]
- Length tolerance: $\pm 0,5$ [mm/m]
- Thickness tolerance: $\pm 0,2$ [mm]

Technical Data

Belt width b [mm]	Allowable tensile load Type M F_{Tzul} [N]	Allowable tensile load Type V F_{Tzul} [N]	Breaking load Type M F_{Br} [N]	Specific spring rate C_{spez} [N]	Weight [kg/m]
10	320	160	1250	80000	0,02
15	540	270	2125	135000	0,03
25	900	450	3500	225000	0,06
50	1860	930	7250	465000	0,12
100	3780	1890	14750	945000	0,24

Other widths are available on request.

Load / Elongation [%]

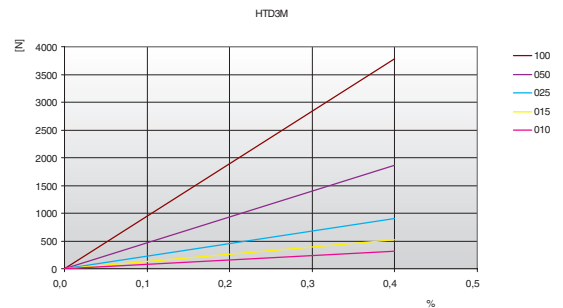

Tooth shear strength

rpm	F_{Uspez} [N/cm]	rpm	F_{Uspez} [N/cm]	rpm	F_{Uspez} [N/cm]	rpm	F_{Uspez} [N/cm]
0	25,20	800	17,30	1900	12,67	4500	7,05
20	24,60	900	16,75	2000	12,36	5000	6,32
40	24,06	1000	16,24	2200	11,77	5500	5,66
60	23,57	1100	15,75	2400	11,22	6000	5,04
80	23,12	1200	15,29	2600	10,71	6500	4,47
100	22,72	1300	14,86	2800	10,24	7000	3,94
200	21,22	1400	14,45	3000	9,79	7500	3,44
300	20,31	1440	14,29	3200	9,36	8000	2,98
400	19,75	1500	14,06	3400	8,96	8500	2,54
500	19,14	1600	13,69	3600	8,57	9000	2,12
600	18,50	1700	13,33	3800	8,21	9500	1,72
700	17,88	1800	12,99	4000	7,86	10000	1,35

Tooth shear strength / rpm

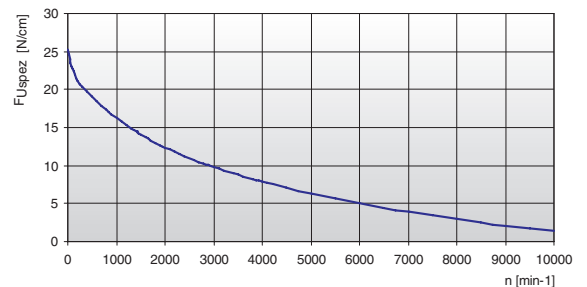

The specific load F_{Uspez} is the maximum load which one single belt tooth 1 cm wide can withstand in all operating conditions.

This force is related to the drive rpm.

The total load F_u transmissible by the belt in the drive is calculated by:

$$F_u [N] = F_{Uspez} \cdot Z_e \cdot b$$

- F_u [N] = peripheral force
- F_{Uspez} [N/cm] = specific load
- Z_e = number of teeth in mesh in the small pulley
- Z_{emax} = max. no of teeth in mesh to be considered for the calculation of the drive
- Z_{emax} = 12 for ELATECH® M
- Z_{emax} = 6 for ELATECH® V
- b [cm] = belt width in cm

HTD 3M

Flexibility

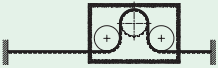
Minimum pulley number of teeth and minimum idler diameter		Type of cord
		STANDARD
Drive without reverse bending 	Timing pulley Z_{min}	20
	Flat idler running on belt teeth d_{min}	30 mm
Drive with reverse bending 	Timing pulley Z_{min}	20
	Flat idler running on belt back d_{min}	30 mm

Timing pulleys

Z	da	dw	Z	da	dw	Z	da	dw	Z	da	dw
10	8,79	9,55	44	41,26	42,02	78	73,73	74,49	112	106,2	106,96
11	9,74	10,50	45	42,21	42,97	79	74,68	75,44	113	107,15	107,91
12	10,70	11,46	46	43,17	43,93	80	75,64	76,40	114	108,11	108,87
13	11,65	12,41	47	44,12	44,88	81	76,59	77,35	115	109,06	109,82
14	12,61	13,37	48	45,08	45,84	82	77,55	78,31	116	110,02	110,78
15	13,56	14,32	49	46,03	46,79	83	78,50	79,26	117	110,97	111,73
16	14,52	15,28	50	46,99	47,75	84	79,46	80,22	118	111,93	112,69
17	15,47	16,23	51	47,94	48,70	85	80,41	81,17	119	112,88	113,64
18	16,43	17,19	52	48,90	49,66	86	81,37	82,13	120	113,83	114,59
19	17,38	18,14	53	49,85	50,61	87	82,32	83,08	121	114,79	115,55
20	18,34	19,10	54	50,81	51,57	88	83,28	84,04	122	115,74	116,50
21	19,29	20,05	55	51,76	52,52	89	84,23	84,99	123	116,70	117,46
22	20,25	21,01	56	52,72	53,48	90	85,19	85,95	124	117,65	118,41
23	21,20	21,96	57	53,67	54,43	91	86,14	86,90	125	118,61	119,37
24	22,16	22,92	58	54,63	55,39	92	87,10	87,86	126	119,56	120,32
25	23,11	23,87	59	55,58	56,34	93	88,05	88,81	127	120,52	121,28
26	24,07	24,83	60	56,54	57,30	94	89,01	89,77	128	121,47	122,23
27	25,02	25,78	61	57,49	58,25	95	89,96	90,72	129	122,43	123,19
28	25,98	26,74	62	58,45	59,21	96	90,92	91,68	130	123,38	124,14
29	26,93	27,69	63	59,40	60,16	97	91,87	92,63	131	124,34	125,10
30	27,89	28,65	64	60,36	61,12	98	92,83	93,59	132	125,29	126,05
31	28,84	29,60	65	61,31	62,07	99	93,78	94,54	133	126,25	127,01
32	29,80	30,56	66	62,27	63,03	100	94,74	95,50	134	127,20	127,96
33	30,75	31,51	67	63,22	63,98	101	95,69	96,45	135	128,16	128,92
34	31,71	32,47	68	64,18	64,94	102	96,65	97,41	136	129,11	129,87
35	32,66	33,42	69	65,13	65,89	103	97,60	98,36	137	130,07	130,83
36	33,62	34,38	70	66,09	66,85	104	98,56	99,32	138	131,02	131,78
37	34,57	35,33	71	67,04	67,80	105	99,51	100,27	139	131,98	132,74
38	35,53	36,29	72	68,00	68,76	106	100,47	101,23	140	132,93	133,69
39	36,48	37,24	73	68,95	69,71	107	101,42	102,18			
40	37,44	38,20	74	69,91	70,67	108	102,38	103,14			
41	38,39	39,15	75	70,86	71,62	109	103,33	104,09			
42	39,35	40,11	76	71,82	72,58	110	104,29	105,05			
43	40,30	41,06	77	72,77	73,53	111	105,24	106,00			

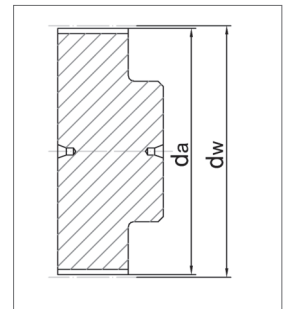

HTD 5M

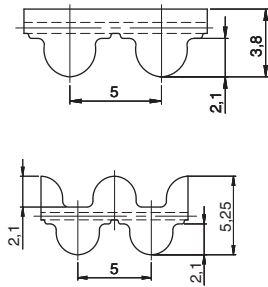

Belt characteristics

- Polyurethane timing belt with round tooth profile and high tensile load tension cords.
- Tooth profile according to ISO 13050
- Metric pitch 5 mm
- The round tooth profile allows a uniform load distribution that guarantees high performances, high transmissible torque and precise tooth engagement
- Widely used in linear positioning, light power transmission applications
- Double sided tooth construction available

- Width tolerance: $\pm 0,5$ [mm]
- Length tolerance: $\pm 0,5$ [mm/m]
- Thickness tolerance: $\pm 0,2$ [mm]

Technical Data

Belt width b [mm]	Allowable tensile load Type M F_{Tzul} [N]	Allowable tensile load Type V F_{Tzul} [N]	Breaking load Type M F_{Br} [N]	Specific spring rate C_{spez} [N]	Weight [kg/m]
10	920	460	3360	230000	0,050
15	1500	750	5460	375000	0,070
25	2650	1325	9660	662500	0,120
50	5520	2760	20160	1380000	0,240
75	8395	4197	30660	2098750	0,360
100	11270	5635	41160	2817500	0,480

Other widths are available on request.

Load / Elongation [%]

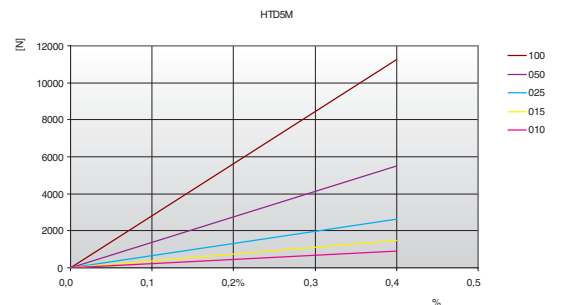

Tooth shear strength

rpm	F_{Uspez} [N/cm]	rpm	F_{Uspez} [N/cm]	rpm	F_{Uspez} [N/cm]	rpm	F_{Uspez} [N/cm]
0	36,80	800	27,21	1900	22,24	4500	16,40
20	36,25	900	26,61	2000	21,91	5000	15,64
40	35,75	1000	26,05	2200	21,30	5500	14,95
60	35,30	1100	25,52	2400	20,72	6000	14,32
80	34,89	1200	25,03	2600	20,19	6500	13,74
100	34,52	1300	24,56	2800	19,69	7000	13,19
200	33,13	1400	24,13	3000	19,23	7500	12,68
300	30,87	1440	23,96	3200	18,78	8000	12,20
400	30,10	1500	23,71	3400	18,37	8500	11,75
500	29,31	1600	23,32	3600	17,97	9000	11,33
600	28,56	1700	22,94	3800	17,59	9500	10,92
700	27,86	1800	22,58	4000	17,23	10000	10,53

Tooth shear strength / rpm

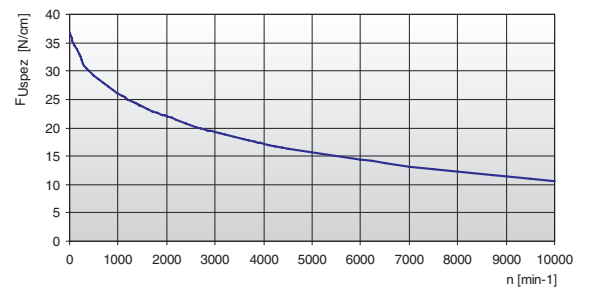

The specific load F_{Uspez} is the maximum load which one single belt tooth 1 cm wide can withstand in all operating conditions. This force is related to the drive rpm.

The total load F_u transmissible by the belt in the drive is calculated by:

$$F_u [N] = F_{Uspez} \cdot Z_e \cdot b$$

- F_u [N] = peripheral force
- F_{Uspez} [N/cm] = specific load
- Z_e = number of teeth in mesh in the small pulley
- Z_{emax} = max. no of teeth in mesh to be considered for the calculation of the drive
- Z_{emax} = 12 for ELATECH® M
- Z_{emax} = 6 for ELATECH® V
- b [cm] = belt width in cm

HTD 5M

Specialties

Belt width b [mm]	ARAMID CORD		STAINLESS STEEL	
	F _{Tzul} [N] M type	F _{Br} [N]	F _{Tzul} [N] M type	F _{Br} [N]
10	880	3600	600	2400
15	1430	5850	980	3900
25	2530	10350	1730	6900
50	5280	21600	3600	14400
75	8030	32850	5475	21900
100	10780	44100	7350	29400

Flexibility

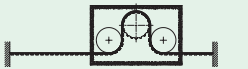
Minimum pulley number of teeth and minimum idler diameter		Type of cord		
		STANDARD	ARAMID	STAINLESS
Drive without reverse bending 	Timing pulley z _{min}	16	16	18
	Flat idler running on belt teeth d _{min}	30 mm	30 mm	40 mm
Drive with reverse bending 	Timing pulley z _{min}	25	25	25
	Flat idler running on belt back d _{min}	60 mm	60 mm	65 mm

Timing pulleys

z	da	dw	z	da	dw	z	da	dw	z	da	dw
10	14,77	15,91	40	62,52	63,66	70	110,27	111,41	100	158,01	159,15
11	16,36	17,50	41	64,11	65,25	71	111,86	113,00	101	159,61	160,75
12	17,96	19,10	42	65,70	66,84	72	113,45	114,59	102	161,2	162,34
13	19,55	20,69	43	67,29	68,43	73	115,04	116,18	103	162,81	163,95
14	21,14	22,28	44	68,88	70,02	74	116,63	117,77	104	164,38	165,52
15	22,73	23,87	45	70,47	71,61	75	118,22	119,36	105	165,97	167,11
16	24,32	25,46	46	72,06	73,20	76	119,81	120,95	106	167,56	168,70
17	25,91	27,05	47	73,65	74,79	77	121,40	122,54	107	169,09	170,23
18	27,51	28,65	48	75,24	76,38	78	122,99	124,13	108	170,75	171,89
19	29,09	30,23	49	76,84	77,98	79	124,58	125,72	109	172,34	173,48
20	30,69	31,83	50	78,44	79,58	80	126,18	127,32	110	173,93	175,07
21	32,28	33,42	51	80,03	81,17	81	127,77	128,91	111	175,52	176,66
22	33,87	35,01	52	81,62	82,76	82	129,36	130,50	112	177,11	178,25
23	35,46	36,60	53	83,21	84,35	83	130,95	132,09	113	178,70	179,84
24	37,06	38,20	54	84,80	85,94	84	132,54	133,68	114	180,29	181,43
25	38,64	39,78	55	86,39	87,53	85	134,14	135,28	115	181,88	183,02
26	40,24	41,38	56	87,98	89,12	86	135,73	136,87	116	183,47	184,61
27	41,83	42,97	57	89,57	90,71	87	137,32	138,46	117	185,07	186,21
28	43,42	44,56	58	91,17	92,31	88	138,91	140,05	118	186,66	187,80
29	45,01	46,15	59	92,76	93,90	89	140,51	141,65	119	188,25	189,39
30	46,61	47,75	60	94,35	95,49	90	142,10	143,24	120	189,84	190,98
31	48,19	49,33	61	95,94	97,08	91	143,69	144,83			
32	49,79	50,93	62	97,53	98,67	92	145,28	146,42			
33	51,38	52,52	63	99,12	100,26	93	146,87	148,01			
34	52,97	54,11	64	100,72	101,86	94	148,46	149,60			
35	54,56	55,70	65	102,31	103,45	95	150,06	151,20			
36	56,16	57,30	66	103,90	105,04	96	151,64	152,78			
37	57,75	58,89	67	105,49	106,63	97	153,24	154,38			
38	59,34	60,48	68	107,08	108,22	98	154,83	155,97			
39	60,93	62,07	69	108,67	109,81	99	156,42	157,56			

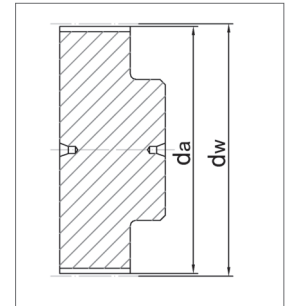

HTD 8M

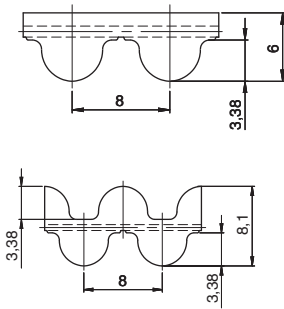

Belt characteristics

- Polyurethane timing belt with round tooth profile and high tensile load tension cords.
- Tooth profile according to ISO 13050
- Metric pitch 8 mm
- The round tooth profile allows a uniform load distribution that guarantees high performances, high transmissible torque and precise tooth engagement
- Widely used in linear positioning, medium power transmission applications
- Double sided tooth construction available

- Width tolerance: $\pm 0,5$ [mm]
- Length tolerance: $\pm 0,5$ [mm/m]
- Thickness tolerance: $\pm 0,2$ [mm]

Technical Data

Belt width > b [mm]	Allowable tensile load Type M F_{Tzul} [N]	Allowable tensile load Type V F_{Tzul} [N]	Breaking load Type M F_{Br} [N]	Specific spring rate C_{spez} [N]	Weight [kg/m]
10	1470	735	5700	367500	0,07
15	2210	1105	8550	552500	0,10
20	3190	1595	12350	797500	0,14
30	4660	2330	18050	1165000	0,21
50	8580	4290	33250	2145000	0,35
85	14700	7350	57000	3675000	0,59
100	17400	8700	67450	4350000	0,69

Other widths are available on request.

Load / Elongation [%]

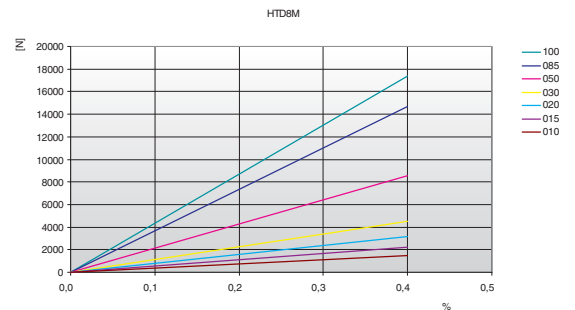

Tooth shear strength

rpm	F_{Uspez} [N/cm]	rpm	F_{Uspez} [N/cm]	rpm	F_{Uspez} [N/cm]	rpm	F_{Uspez} [N/cm]
0	74,00	800	51,20	1900	39,52	4500	26,63
20	72,62	900	49,71	2000	38,78	5000	25,00
40	71,34	1000	48,35	2200	37,39	5500	23,51
60	70,16	1100	47,09	2400	36,12	6000	22,15
80	69,07	1200	45,93	2600	34,94	-	-
100	68,07	1300	44,84	2800	33,83	-	-
200	64,09	1400	43,82	3000	32,80	-	-
300	61,68	1440	43,43	3200	31,83	-	-
400	59,03	1500	42,86	3400	30,91	-	-
500	56,71	1600	41,96	3600	30,05	-	-
600	54,66	1700	41,10	3800	29,22	-	-
700	52,84	1800	40,29	4000	28,44	-	-

Tooth shear strength / rpm

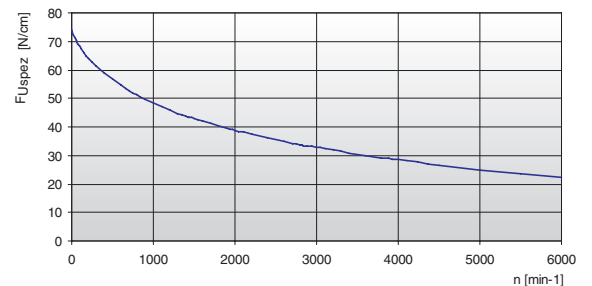

The specific load F_{Uspez} is the maximum load which one single belt tooth 1 cm wide can withstand in all operating conditions.

This force is related to the drive rpm.

The total load F_u transmissible by the belt in the drive is calculated by:

$$F_u [N] = F_{Uspez} \cdot Z_e \cdot b$$

- $F_u [N]$ = peripheral force
- $F_{Uspez} [N/cm]$ = specific load
- Z_e = number of teeth in mesh in the small pulley
- Z_{emax} = max. no of teeth in mesh to be considered for the calculation of the drive
- Z_{emax} = 12 for ELATECH® M
- Z_{emax} = 6 for ELATECH® V
- $b [cm]$ = belt width in cm

HTD 8M

Specialties

Belt width b [mm]	ARAMID CORD		STAINLESS STEEL		HPL High Performance	
	F _{Tzul} [N] M type	F _{Br} [N]	F _{Tzul} [N] M type	F _{Br} [N]	F _{Tzul} [N] M type	F _{Br} [N]
10	1140	4740	1080	4500	-	-
15	1710	7110	1620	6750	-	-
20	2470	10270	2340	9750	5280	19250
30	3800	15800	3600	15000	8160	29750
50	6650	27650	6300	26250	14400	52500
85	11400	47400	10800	45000	24480	89250
100	13500	56000	12780	53250	29280	106750

Flexibility

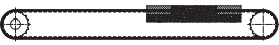
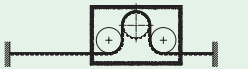
Minimum pulley number of teeth and minimum idler diameter		Type of cord			
		STANDARD	ARAMID	STAINLESS	HPL
Drive without reverse bending 	Timing pulley z _{min}	18	18	24	30
	Flat idler running on belt teeth d _{min}	50 mm	50 mm	70 mm	80 mm
Drive with reverse bending 	Timing pulley z _{min}	30	30	40	30
	Flat idler running on belt back d _{min}	120 mm	120 mm	100 mm	150 mm

Timing pulleys

z	da	dw	z	da	dw	z	da	dw	z	da	dw
18	44,46	45,83	48	120,86	122,23	78	197,25	198,62	108	273,64	275,01
19	47,01	48,38	49	123,40	124,77	79	199,80	201,17	109	276,19	277,56
20	49,56	50,93	50	125,95	127,32	80	202,35	203,72	110	278,74	280,11
21	52,10	53,47	51	128,50	129,87	81	204,89	206,26	111	281,29	282,66
22	54,65	56,02	52	131,05	132,41	82	207,44	208,81	112	283,84	285,21
23	57,20	58,57	53	133,59	134,96	83	209,98	211,35	113	286,38	287,75
24	59,75	61,12	54	136,14	137,51	84	212,53	213,90	114	288,93	290,30
25	62,29	63,66	55	138,68	140,05	85	215,08	216,45	115	291,47	292,84
26	64,84	66,21	56	141,23	142,60	86	217,63	219,00	116	294,02	295,39
27	67,38	68,75	57	143,78	145,15	87	220,17	221,54	117	296,57	297,94
28	70,08	71,30	58	146,32	147,69	88	222,72	224,09	118	299,11	300,48
29	72,59	73,84	59	148,87	150,24	89	225,26	226,63	119	301,66	303,03
30	75,13	76,39	60	151,42	152,79	90	227,81	229,18	120	304,20	305,57
31	77,65	78,94	61	153,96	155,33	91	230,35	231,72			
32	80,16	81,49	62	156,52	157,89	92	232,90	234,27			
33	82,68	84,03	63	159,06	160,43	93	235,45	236,82			
34	85,21	86,58	64	161,60	162,97	94	238,00	239,37			
35	87,76	89,12	65	164,15	165,52	95	240,54	241,91			
36	90,30	91,67	66	166,69	168,06	96	243,09	244,46			
37	92,85	94,22	67	169,24	170,61	97	245,63	247,00			
38	95,40	96,77	68	171,79	173,16	98	248,18	249,55			
39	97,94	99,31	69	174,33	175,70	99	250,73	252,10			
40	100,49	101,86	70	176,88	178,25	100	253,28	254,67			
41	103,04	104,40	71	179,43	180,80	101	255,82	257,19			
42	105,58	106,95	72	181,98	183,35	102	258,37	259,74			
43	108,13	109,50	73	184,52	185,89	103	260,91	262,28			
44	110,68	112,05	74	187,07	188,44	104	263,46	264,83			
45	113,22	114,59	75	189,61	190,98	105	266,01	267,38			
46	115,77	117,14	76	192,16	193,53	106	268,55	269,92			
47	118,31	119,68	77	194,71	196,08	107	271,10	272,47			

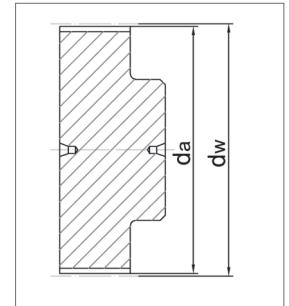

HTD 14M

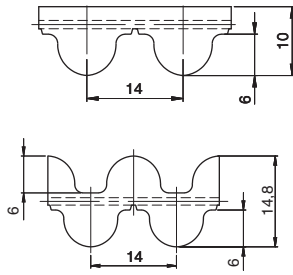

Belt characteristics

- Polyurethane timing belt with round tooth profile and high tensile load tension cords.
- Tooth profile according to ISO 13050
- Metric pitch 14 mm
- The round tooth profile allows a uniform load distribution that guarantees high performances, high transmissible torque and precise tooth engagement
- Widely used in linear positioning, heavy power transmission applications
- Double sided tooth construction available

- Width tolerance: $\pm 1,0$ [mm]
- Length tolerance: $\pm 0,5$ [mm/m]
- Thickness tolerance: $\pm 0,4$ [mm]

Technical Data

Belt width b [mm]	Allowable tensile load Type M F_{Tzul} [N]	Allowable tensile load Type V F_{Tzul} [N]	Breaking load Type M F_{Br} [N]	Specific spring rate C_{spez} [N]	Weight [kg/m]
25	5280	2640	19250	1320000	0,28
40	9120	4560	33250	2280000	0,44
55	12480	6240	45500	3120000	0,61
85	19680	9840	71750	4920000	0,94
115	26880	13440	98000	6720000	1,25
150	35520	17760	129500	8880000	1,68

Load / Elongation [%]

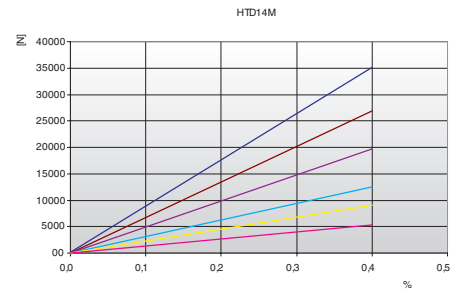

Other widths are available on request.

Tooth shear strength

rpm	F_{Uspez} [N/cm]	rpm	F_{Uspez} [N/cm]	rpm	F_{Uspez} [N/cm]
0	130,00	800	83,80	1900	60,49
20	127,69	900	80,85	2000	59,01
40	125,56	1000	78,14	2200	56,23
60	123,60	1100	75,63	2400	53,68
80	121,78	1200	73,31	2600	51,30
100	120,11	1300	71,14	2800	49,09
200	109,77	1400	69,11	3000	47,01
300	104,29	1440	68,33	3200	45,06
400	99,19	1500	67,19	3400	43,22
500	94,65	1600	65,38	3600	41,48
600	90,64	1700	63,67	3800	39,82
700	87,04	1800	62,04	4000	38,24

Tooth shear strength / rpm

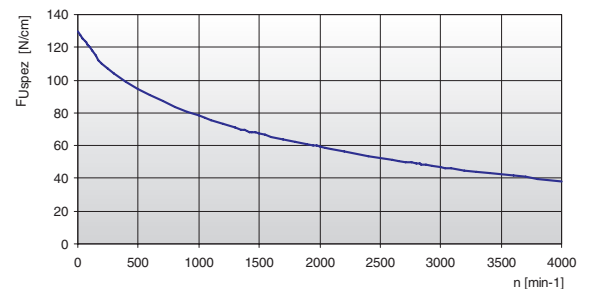

The specific load F_{Uspez} is the maximum load which one single belt tooth 1 cm wide can withstand in all operating conditions. This force is related to the drive rpm.

The total load F_u transmissible by the belt in the drive is calculated by:

$$F_u [N] = F_{Uspez} \cdot Z_e \cdot b$$

- $F_u [N]$ = peripheral force
- $F_{Uspez} [N/cm]$ = specific load
- Z_e = number of teeth in mesh in the small pulley
- Z_{emax} = max. no of teeth in mesh to be considered for the calculation of the drive
- Z_{emax} = 12 for ELATECH® M
- Z_{emax} = 6 for ELATECH® V
- $b [cm]$ = belt width in cm

HTD 14M

Flexibility

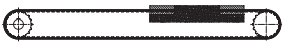
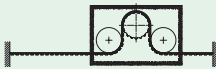
Minimum pulley number of teeth and minimum idler diameter		Type of cord
		STANDARD
Drive without reverse bending 	Timing pulley z_{min}	28
	Flat idler running on belt teeth d_{min}	120 mm
Drive with reverse bending 	Timing pulley z_{min}	28
	Flat idler running on belt back d_{min}	180 mm

Timing pulleys

z	da	dw	z	da	dw	z	da	dw	z	da	dw
28	122,12	124,77	58	255,68	258,46	88	389,37	392,15	119	527,51	530,30
29	126,58	129,22	59	260,14	262,91	89	393,83	396,60	120	531,97	534,75
30	130,99	133,69	60	264,60	267,38	90	398,29	401,07			
31	135,45	138,14	61	269,04	271,83	91	402,73	405,52			
32	139,88	142,59	62	273,50	276,28	92	407,19	409,97			
33	144,35	147,06	63	277,96	280,75	93	411,65	414,44			
34	148,79	151,51	64	282,42	285,20	94	416,10	418,89			
35	153,25	155,96	65	286,88	289,65	95	420,56	423,35			
36	157,68	160,41	66	291,32	294,11	96	425,02	427,80			
37	162,14	164,88	67	295,78	298,56	97	429,48	432,25			
38	166,60	169,34	68	300,24	303,03	98	433,94	436,72			
39	171,02	173,79	69	304,70	307,48	99	438,38	441,17			
40	175,48	178,24	70	309,16	311,93	100	442,84	445,62			
41	179,92	182,71	71	313,61	316,40	101	447,30	450,09			
42	184,37	187,16	72	318,07	320,85	102	451,76	454,54			
43	188,83	191,61	73	322,53	325,30	103	456,21	459,00			
44	193,29	196,08	74	326,98	329,77	104	460,67	463,45			
45	197,75	200,53	75	331,44	334,22	105	465,13	467,90			
46	202,21	204,98	76	335,90	338,67	106	469,58	472,37			
47	206,65	209,43	77	340,34	343,12	107	474,03	476,82			
48	211,11	213,90	78	344,80	347,59	108	478,49	481,28			
49	215,57	218,35	79	349,26	352,04	109	482,95	485,74			
50	220,03	222,80	80	353,72	356,49	110	487,41	490,19			
51	224,49	227,27	81	358,17	360,96	111	491,87	494,64			
52	228,95	231,72	82	362,63	365,41	112	496,32	499,10			
53	233,39	236,18	83	367,09	369,86	113	500,78	503,55			
54	237,85	240,64	84	371,54	374,33	114	505,23	508,02			
55	242,30	245,09	85	376,00	378,78	116	514,14	516,93			
56	246,76	249,55	86	380,46	383,23	117	518,60	521,38			
57	251,22	254,01	87	384,91	387,70	118	523,06	525,83			

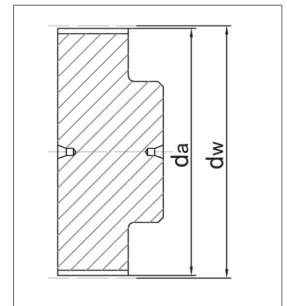

HTD 14M XHPL

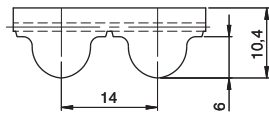

Belt characteristics

- Polyurethane timing belt with round tooth profile and high tensile load tension cords.
- Tooth profile according to ISO 13050
- Metric pitch 14 mm
- The round tooth profile allows a uniform load distribution that guarantees high performances, high transmissible torque and precise tooth engagement
- **HTD14M - XHPL is the ideal belt for heavy duty synchronous lifting applications**
- **Black color and PAZ fabric as standard for XHPL execution**

- Width tolerance: $\pm 1,0$ [mm]
- Length tolerance: $\pm 0,5$ [mm/m]
- Thickness tolerance: $\pm 0,5$ [mm]

Technical Data - HTD14M XHPL

Belt width b [mm]	Allowable tensile load Type M F_{Tzul} [N]	Breaking load Type M F_{Br} [N]	Specific spring rate C_{spez} [N]	Weight [kg/m]
40	22000	77000	5500000	0,59
55	32000	112000	8000000	0,75
85	50000	175000	12500000	1,29
115	68000	238000	17000000	1,75
150	90000	315000	22500000	2,21

Other widths are available on request.

Load / Elongation [%]

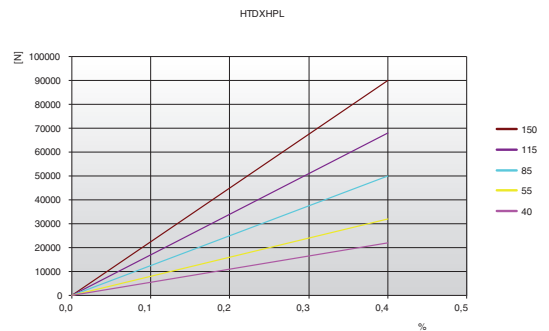

Tooth shear strength

rpm	F_{Uspez} [N/cm]	rpm	F_{Uspez} [N/cm]	rpm	F_{Uspez} [N/cm]
0	130,00	800	83,80	1900	60,49
20	127,69	900	80,85	2000	59,01
40	125,56	1000	78,14	2200	56,23
60	123,60	1100	75,63	2400	53,68
80	121,78	1200	73,31	2600	51,30
100	120,11	1300	71,14	2800	49,09
200	109,77	1400	69,11	3000	47,01
300	104,29	1440	68,33	3200	45,06
400	99,19	1500	67,19	3400	43,22
500	94,65	1600	65,38	3600	41,48
600	90,64	1700	63,67	3800	39,82
700	87,04	1800	62,04	4000	38,24

Tooth shear strength / rpm

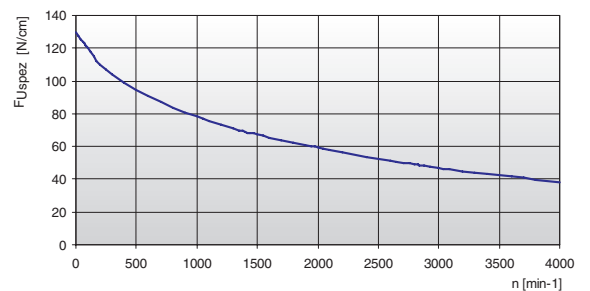

The specific load F_{Uspez} is the maximum load which one single belt tooth 1 cm wide can withstand in all operating conditions. This force is related to the drive rpm.

The total load F_u transmissible by the belt in the drive is calculated by:

$$F_u [N] = F_{Uspez} \cdot Z_e \cdot b$$

- F_u [N] = peripheral force
- F_{Uspez} [N/cm] = specific load
- Z_e = number of teeth in mesh in the small pulley
- Z_{emax} = max. no of teeth in mesh to be considered for the calculation of the drive
- Z_{emax} = 12 for ELATECH® M
- Z_{emax} = 6 for ELATECH® V
- b [cm] = belt width in cm

HTD 14M XHPL

Flexibility

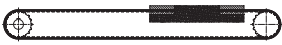
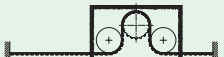
Minimum pulley number of teeth and minimum idler diameter		Type of cord
		STANDARD
Drive without reverse bending 	Timing pulley z_{min}	34
	Flat idler running on belt teeth d_{min}	140 mm
Drive with reverse bending 	Timing pulley z_{min}	34
	Flat idler running on belt back d_{min}	200 mm

Timing pulleys

z	da	dw
28	122,12	124,77
29	126,58	129,22
30	130,99	133,69
31	135,45	138,14
32	139,88	142,59
33	144,35	147,06
34	148,79	151,51
35	153,25	155,96
36	157,68	160,41
37	162,14	164,88
38	166,60	169,34
39	171,02	173,79
40	175,48	178,24
41	179,92	182,71
42	184,37	187,16
43	188,83	191,61
44	193,29	196,08
45	197,75	200,53
46	202,21	204,98
47	206,65	209,43
48	211,11	213,90
49	215,57	218,35
50	220,03	222,80
51	224,49	227,27
52	228,95	231,72
53	233,39	236,18
54	237,85	240,64
55	242,30	245,09
56	246,76	249,55
57	251,22	254,01

z	da	dw
58	255,68	258,46
59	260,14	262,91
60	264,60	267,38
61	269,04	271,83
62	273,50	276,28
63	277,96	280,75
64	282,42	285,20
65	286,88	289,65
66	291,32	294,11
67	295,78	298,56
68	300,24	303,03
69	304,70	307,48
70	309,16	311,93
71	313,61	316,40
72	318,07	320,85
73	322,53	325,30
74	326,98	329,77
75	331,44	334,22
76	335,90	338,67
77	340,34	343,12
78	344,80	347,59
79	349,26	352,04
80	353,72	356,49
81	358,17	360,96
82	362,63	365,41
83	367,09	369,86
84	371,54	374,33
85	376,00	378,78
86	380,46	383,23
87	384,91	387,70

z	da	dw
88	389,37	392,15
89	393,83	396,60
90	398,29	401,07
91	402,73	405,52
92	407,19	409,97
93	411,65	414,44
94	416,10	418,89
95	420,56	423,35
96	425,02	427,80
97	429,48	432,25
98	433,94	436,72
99	438,38	441,17
100	442,84	445,62
101	447,30	450,09
102	451,76	454,54
103	456,21	459,00
104	460,67	463,45
105	465,13	467,90
106	469,58	472,37
107	474,03	476,82
108	478,49	481,28
109	482,95	485,74
110	487,41	490,19
111	491,87	494,64
112	496,32	499,10
113	500,78	503,55
114	505,23	508,02
116	514,14	516,93
117	518,60	521,38
118	523,06	525,83

z	da	dw
119	527,51	530,30
120	531,97	534,75

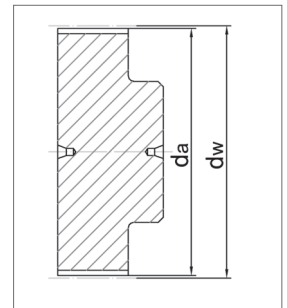

RTD 5M

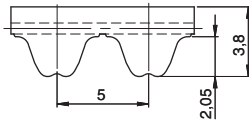

Belt characteristics

- Polyurethane timing belt with round tooth profile and high tensile load tension cords.
- Tooth profile according to ISO 13050
- Metric pitch 5 mm
- The round tooth profile allows a uniform load distribution that guarantees high performances, high transmissible torque and precise tooth engagement
- PAZ fabric on tooth side delivered as standard reduces noise in the drive
- Widely used in linear positioning, light power transmission applications

- Width tolerance: $\pm 0,5$ [mm]
- Length tolerance: $\pm 0,5$ [mm/m]
- Thickness tolerance: $\pm 0,2$ [mm]

Technical Data

Belt width b [mm]	Allowable tensile load Type M F_{Tzul} [N]	Allowable tensile load Type V F_{Tzul} [N]	Breaking load Type M F_{Br} [N]	Specific spring rate C_{spez} [N]	Weight [kg/m]
10	920	460	3360	230000	0,05
15	1500	750	5460	375000	0,07
25	2650	1325	9660	662500	0,12
30	3220	1610	11760	805000	0,15
50	5520	2760	20160	1380000	0,23
100	11270	5635	41160	2817500	0,46

Other widths are available on request.

Load / Elongation [%]

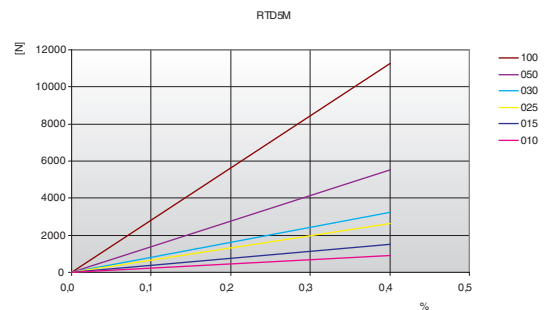

Tooth shear strength

rpm	F_{Uspez} [N/cm]	rpm	F_{Uspez} [N/cm]	rpm	F_{Uspez} [N/cm]	rpm	F_{Uspez} [N/cm]
0	37,80	900	28,61	2200	23,30	5500	16,95
20	37,25	1000	28,05	2400	22,72	6000	16,32
40	36,75	1100	27,52	2600	22,19	6500	15,74
60	36,30	1200	27,03	2800	21,69	7000	15,19
80	35,89	1300	26,56	2880	21,50	7500	14,68
100	35,52	1400	26,13	3000	21,23	8000	14,20
200	34,13	1440	25,96	3200	20,78	8500	13,75
300	32,87	1500	25,71	3400	20,37	9000	13,33
400	32,10	1600	25,32	3600	19,97	9500	12,92
500	31,31	1700	24,94	3800	19,59	10000	12,53
600	30,56	1800	24,58	4000	19,23	-	-
700	29,86	1900	24,24	4500	18,40	-	-
800	29,21	2000	23,91	5000	17,64	-	-

Tooth shear strength / rpm

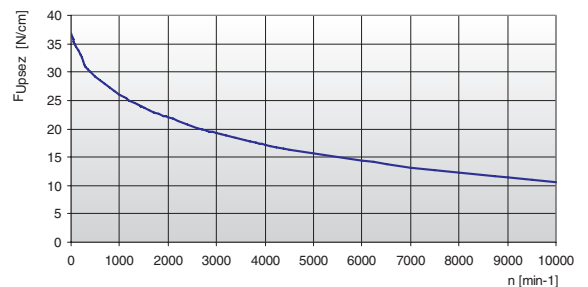

The specific load F_{Uspez} is the maximum load which one single belt tooth 1 cm wide can withstand in all operating conditions.

This force is related to the drive rpm.

The total load F_u transmissible by the belt in the drive is calculated by:

$$F_u [N] = F_{Uspez} \cdot Z_e \cdot b$$

- $F_u [N]$ = peripheral force
- $F_{Uspez} [N/cm]$ = specific load
- Z_e = number of teeth in mesh in the small pulley
- Z_{emax} = max. no of teeth in mesh to be considered for the calculation of the drive
- Z_{emax} = 12 for ELATECH® M
- Z_{emax} = 6 for ELATECH® V
- $b [cm]$ = belt width in cm

RTD 5M

Specialties

Belt width b [mm]	ARAMID CORD		STAINLESS STEEL		HFE High Flexibility	
	F _{Tzul} [N] M type	F _{Br} [N]	F _{Tzul} [N] M type	F _{Br} [N]	F _{Tzul} [N] M type	F _{Br} [N]
10	880	3600	600	2400	960	3440
15	1430	5850	1730	3900	1560	5590
25	2530	10350	2100	6900	2760	9890
30	3080	12600	2100	8400	3360	12040
50	5280	21600	3600	14400	5760	20640
100	10780	44100	-	-	-	-

Flexibility

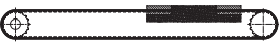
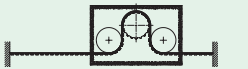
Minimum pulley number of teeth and minimum idler diameter		Type of cord			
		STANDARD	ARAMID	STAINLESS	HFE
Drive without reverse bending 	Timing pulley z _{min}	16	16	18	15
	Flat idler running on belt teeth d _{min}	30 mm	30 mm	40 mm	25 mm
Drive with reverse bending 	Timing pulley z _{min}	25	25	25	20
	Flat idler running on belt back d _{min}	60 mm	60 mm	65 mm	60 mm

Timing pulleys

z	da	dw	z	da	dw	z	da	dw	z	da	dw
10	14,77	15,91	40	62,52	63,66	70	110,27	111,41	100	158,01	159,15
11	16,36	17,50	41	64,11	65,25	71	111,86	113,00	101	159,61	160,75
12	17,96	19,10	42	65,70	66,84	72	113,45	114,59	102	161,20	162,34
13	19,55	20,69	43	67,29	68,43	73	115,04	116,18	103	162,81	163,95
14	21,14	22,28	44	68,88	70,02	74	116,63	117,77	104	164,38	165,52
15	22,73	23,87	45	70,47	71,61	75	118,22	119,36	105	165,97	167,11
16	24,32	25,46	46	72,06	73,20	76	119,81	120,95	106	167,56	168,70
17	25,91	27,05	47	73,65	74,79	77	121,40	122,54	107	169,09	170,23
18	27,51	28,65	48	75,24	76,38	78	122,99	124,13	108	170,75	171,89
19	29,09	30,23	49	76,84	77,98	79	124,58	125,72	109	172,34	173,48
20	30,69	31,83	50	78,44	79,58	80	126,18	127,32	110	173,93	175,07
21	32,28	33,42	51	80,03	81,17	81	127,77	128,91	111	175,52	176,66
22	33,87	35,01	52	81,62	82,76	82	129,36	130,50	112	177,11	178,25
23	35,46	36,60	53	83,21	84,35	83	130,95	132,09	113	178,70	179,84
24	37,06	38,20	54	84,80	85,94	84	132,54	133,68	114	180,29	181,43
25	38,64	39,78	55	86,39	87,53	85	134,14	135,28	115	181,88	183,02
26	40,24	41,38	56	87,98	89,12	86	135,73	136,87	116	183,47	184,61
27	41,83	42,97	57	89,57	90,71	87	137,32	138,46	117	185,07	186,21
28	43,42	44,56	58	91,17	92,31	88	138,91	140,05	118	186,66	187,80
29	45,01	46,15	59	92,76	93,90	89	140,51	141,65	119	188,25	189,39
30	46,61	47,75	60	94,35	95,49	90	142,10	143,24	120	189,84	190,98
31	48,19	49,33	61	95,94	97,08	91	143,69	144,83			
32	49,79	50,93	62	97,53	98,67	92	145,28	146,42			
33	51,38	52,52	63	99,12	100,26	93	146,87	148,01			
34	52,97	54,11	64	100,72	101,86	94	148,46	149,60			
35	54,56	55,70	65	102,31	103,45	95	150,06	151,20			
36	56,16	57,30	66	103,90	105,04	96	151,64	152,78			
37	57,75	58,89	67	105,49	106,63	97	153,24	154,38			
38	59,34	60,48	68	107,08	108,22	98	154,83	155,97			
39	60,93	62,07	69	108,67	109,81	99	156,42	157,56			

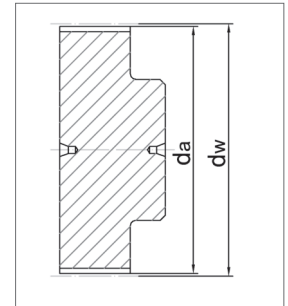

RTD 8M

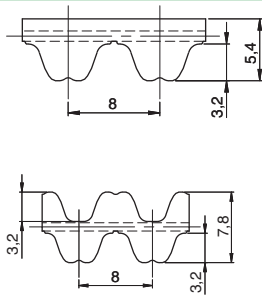

Belt characteristics

- Polyurethane timing belt with round tooth profile and high tensile load tension cords.
- Tooth profile according to ISO 13050
- Metric pitch 8 mm
- The round tooth profile allows a uniform load distribution that guarantees high performances, high transmissible torque and precise tooth engagement
- PAZ fabric on tooth side delivered as standard reduces noise in the drive
- Widely used in linear positioning, medium power transmission applications

- Width tolerance: $\pm 0,5$ [mm]
- Length tolerance: $\pm 0,5$ [mm/m]
- Thickness tolerance: $\pm 0,2$ [mm]

Technical Data

Belt width b [mm]	Allowable tensile load Type M F_{Tzul} [N]	Allowable tensile load Type V F_{Tzul} [N]	Breaking load Type M F_{Br} [N]	Specific spring rate C_{spez} [N]	Weight [kg/m]
10	1470	735	5700	367500	0,07
15	2210	1105	8550	552500	0,10
20	3190	1595	12350	797500	0,14
30	4660	2330	18050	1165000	0,20
50	8580	4290	33250	2145000	0,35
85	14700	7350	57000	3675000	0,60
100	17400	8700	67450	4350000	0,75

Other widths are available on request.

Load / Elongation [%]

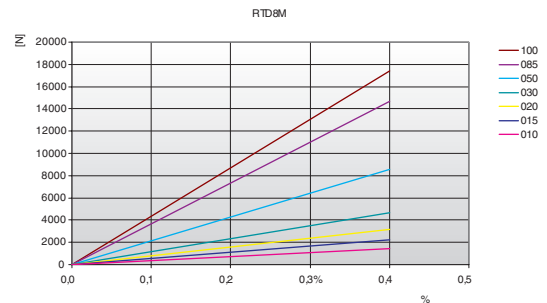

Tooth shear strength

rpm	F_{Uspez} [N/cm]	rpm	F_{Uspez} [N/cm]	rpm	F_{Uspez} [N/cm]	rpm	F_{Uspez} [N/cm]
0	76,00	800	53,20	1900	41,52	4000	30,44
20	74,62	900	51,71	2000	40,78	4500	28,63
40	73,34	1000	50,35	2200	39,39	5000	27,00
60	72,16	1100	49,09	2400	38,12	5500	25,51
80	71,07	1200	47,93	2600	36,94	6000	24,15
100	70,07	1300	46,84	2800	35,83	-	-
200	66,09	1400	45,82	2880	35,41	-	-
300	63,68	1440	45,43	3000	34,80	-	-
400	61,03	1500	44,86	3200	33,83	-	-
500	58,71	1600	43,96	3400	32,91	-	-
600	56,66	1700	43,10	3600	32,05	-	-
700	54,84	1800	42,29	3800	31,22	-	-

Tooth shear strength / rpm

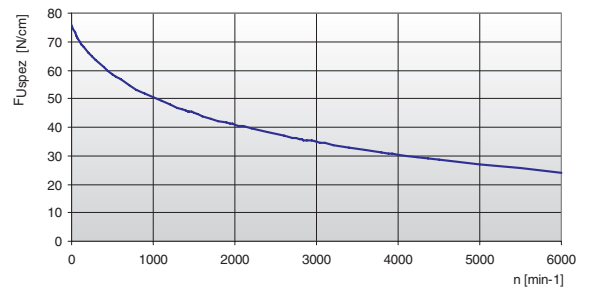

The specific load F_{Uspez} is the maximum load which one single belt tooth 1 cm wide can withstand in all operating conditions. This force is related to the drive rpm.

The total load F_u transmissible by the belt in the drive is calculated by:

$$F_u [N] = F_{Uspez} \cdot Z_e \cdot b$$

- $F_u [N]$ = peripheral force
- $F_{Uspez} [N/cm]$ = specific load
- Z_e = number of teeth in mesh in the small pulley
- Z_{emax} = max. no of teeth in mesh to be considered for the calculation of the drive
- Z_{emax} = 12 for ELATECH® M
- Z_{emax} = 6 for ELATECH® V
- $b [cm]$ = belt width in cm

RTD 8M

Specialties

Belt width b [mm]	ARAMID CORD		STAINLESS STEEL		HPL High Performance	
	F _{Tzul} [N] M type	F _{Br} [N]	F _{Tzul} [N] M type	F _{Br} [N]	F _{Tzul} [N] M type	F _{Br} [N]
10	1140	4740	1080	4500	-	-
15	1710	7110	1620	6750	-	-
20	2470	10270	2340	9750	5280	19250
30	3800	15800	3600	15000	8160	29750
50	6650	27650	6300	26250	14400	52500
85	11400	47400	10800	45000	24480	89250
100	13500	56000	12780	53250	29280	106750

Flexibility

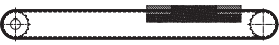
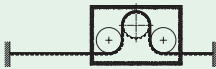
Minimum pulley number of teeth and minimum idler diameter		Type of cord			
		STANDARD	ARAMID	STAINLESS	HPL
Drive without reverse bending 	Timing pulley z _{min}	18	18	24	30
	Flat idler running on belt teeth d _{min}	50 mm	50 mm	70 mm	80 mm
Drive with reverse bending 	Timing pulley z _{min}	30	30	40	30
	Flat idler running on belt back d _{min}	120 mm	120 mm	120 mm	150 mm

Timing pulleys

z	da	dw	z	da	dw	z	da	dw	z	da	dw
18	44,46	45,83	48	120,86	122,23	78	197,25	198,62	108	273,64	275,01
19	47,01	48,38	49	123,40	124,77	79	199,80	201,17	109	276,19	277,56
20	49,56	50,93	50	125,95	127,32	80	202,35	203,72	110	278,74	280,11
21	52,10	53,47	51	128,50	129,87	81	204,89	206,26	111	281,29	282,66
22	54,65	56,02	52	131,05	132,41	82	207,44	208,81	112	283,84	285,21
23	57,20	58,57	53	133,59	134,96	83	209,98	211,35	113	286,38	287,75
24	59,75	61,12	54	136,14	137,51	84	212,53	213,90	114	288,93	290,30
25	62,29	63,66	55	138,68	140,05	85	215,08	216,45	115	291,47	292,84
26	64,84	66,21	56	141,23	142,60	86	217,63	219,00	116	294,02	295,39
27	67,38	68,75	57	143,78	145,15	87	220,17	221,54	117	296,57	297,94
28	70,08	71,30	58	146,32	147,69	88	222,72	224,09	118	299,11	300,48
29	72,59	73,84	59	148,87	150,24	89	225,26	226,63	119	301,66	303,03
30	75,13	76,39	60	151,42	152,79	90	227,81	229,18	120	304,20	305,57
31	77,65	78,94	61	153,96	155,33	91	230,35	231,72			
32	80,16	81,49	62	156,52	157,89	92	232,90	234,27			
33	82,68	84,03	63	159,06	160,43	93	235,45	236,82			
34	85,21	86,58	64	161,60	162,97	94	238,00	239,37			
35	87,76	89,12	65	164,15	165,52	95	240,54	241,91			
36	90,30	91,67	66	166,69	168,06	96	243,09	244,46			
37	92,85	94,22	67	169,24	170,61	97	245,63	247,00			
38	95,40	96,77	68	171,79	173,16	98	248,18	249,55			
39	97,94	99,31	69	174,33	175,70	99	250,73	252,10			
40	100,49	101,86	70	176,88	178,25	100	253,28	254,67			
41	103,04	104,40	71	179,43	180,80	101	255,82	257,19			
42	105,58	106,95	72	181,98	183,35	102	258,37	259,74			
43	108,13	109,50	73	184,52	185,89	103	260,91	262,28			
44	110,68	112,05	74	187,07	188,44	104	263,46	264,83			
45	113,22	114,59	75	189,61	190,98	105	266,01	267,38			
46	115,77	117,14	76	192,16	193,53	106	268,55	269,92			
47	118,31	119,68	77	194,71	196,08	107	271,10	272,47			

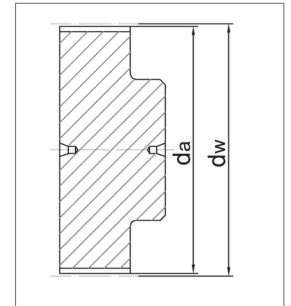

RTD 14M

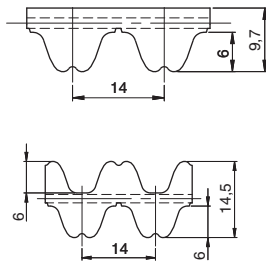

Belt characteristics

- Polyurethane timing belt with round tooth profile and high tensile load tension cords.
- Tooth profile according to ISO 13050
- Metric pitch 14 mm
- The round tooth profile allows a uniform load distribution that guarantees high performances, high transmissible torque and precise tooth engagement
- PAZ fabric on tooth side delivered as standard reduces noise in the drive
- Widely used in linear positioning, heavy power transmission applications

- Width tolerance: $\pm 1,0$ [mm]
- Length tolerance: $\pm 0,5$ [mm/m]
- Thickness tolerance: $\pm 0,4$ [mm]

Technical Data

Belt width b [mm]	Allowable tensile load Type M F_{Tzul} [N]	Allowable tensile load Type V F_{Tzul} [N]	Breaking load Type M F_{Br} [N]	Specific spring rate C_{spez} [N]	Weight [kg/m]
40	12750	6375	48000	3187500	0,48
55	17850	8925	67200	4462500	0,68
85	28050	14025	105600	7012500	1,00
115	39100	19550	147200	9775000	1,40

Other widths are available on request.

Load / Elongation [%]

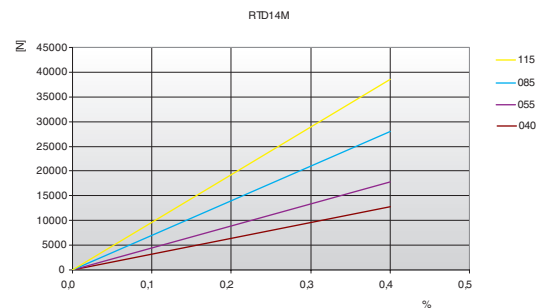

Tooth shear strength

rpm	F_{Uspez} [N/cm]	rpm	F_{Uspez} [N/cm]	rpm	F_{Uspez} [N/cm]	rpm	F_{Uspez} [N/cm]
0	140,00	800	93,80	1900	70,49	4000	48,24
20	137,31	900	90,85	2000	69,01	-	-
40	134,83	1000	88,14	2200	66,23	-	-
60	132,53	1100	85,63	2400	63,68	-	-
80	130,42	1200	83,31	2600	61,30	-	-
100	128,46	1300	81,14	2800	59,09	-	-
200	119,77	1400	79,11	2880	58,24	-	-
300	114,29	1440	78,33	3000	57,01	-	-
400	109,19	1500	77,19	3200	55,06	-	-
500	104,65	1600	75,38	3400	53,22	-	-
600	100,64	1700	73,67	3600	51,48	-	-
700	97,04	1800	72,04	3800	49,82	-	-

Tooth shear strength / rpm

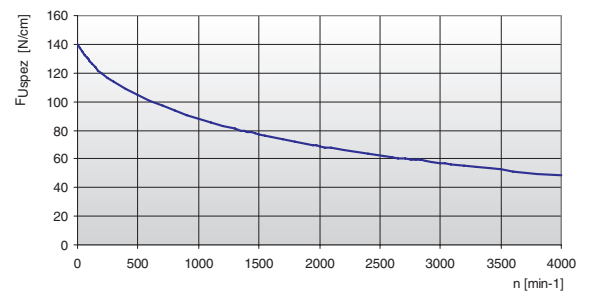

The specific load F_{Uspez} is the maximum load which one single belt tooth 1 cm wide can withstand in all operating conditions.

This force is related to the drive rpm.

The total load F_u transmissible by the belt in the drive is calculated by:

$$F_u [N] = F_{Uspez} \cdot Z_e \cdot b$$

- $F_u [N]$ = peripheral force
- $F_{Uspez} [N/cm]$ = specific load
- Z_e = number of teeth in mesh in the small pulley
- Z_{emax} = max. no of teeth in mesh to be considered for the calculation of the drive
- Z_{emax} = 12 for ELATECH® M
- Z_{emax} = 6 for ELATECH® V
- $b [cm]$ = belt width in cm

RTD 14M

Specialties

Belt width b [mm]	HPL High Performance	
	F_{Tzul} [N] M type	F_{Br} [N]
40	14300	58500
55	19800	81000
75	27500	112500
85	30800	126000
100	35200	144000
115	41800	171000
150	55000	225000

Flexibility

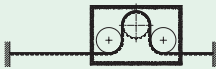
Minimum pulley number of teeth and minimum idler diameter		Type of cord	
		STANDARD	HPL
Drive without reverse bending 	Timing pulley z_{min}	32	32
	Flat idler running on belt teeth d_{min}	140 mm	140 mm
Drive with reverse bending 	Timing pulley z_{min}	32	32
	Flat idler running on belt back d_{min}	200 mm	200 mm

Timing pulleys

z	da	dw	z	da	dw	z	da	dw	z	da	dw
28	122,12	124,77	58	255,68	258,46	88	389,37	392,15	119	527,51	530,30
29	126,58	129,22	59	260,14	262,91	89	393,83	396,60	120	531,97	534,75
30	130,99	133,69	60	264,60	267,38	90	398,29	401,07			
31	135,45	138,14	61	269,04	271,83	91	402,73	405,52			
32	139,88	142,59	62	273,50	276,28	92	407,19	409,97			
33	144,35	147,06	63	277,96	280,75	93	411,65	414,44			
34	148,79	151,51	64	282,42	285,20	94	416,10	418,89			
35	153,25	155,96	65	286,88	289,65	95	420,56	423,35			
36	157,68	160,41	66	291,32	294,11	96	425,02	427,80			
37	162,14	164,88	67	295,78	298,56	97	429,48	432,25			
38	166,60	169,34	68	300,24	303,03	98	433,94	436,72			
39	171,02	173,79	69	304,70	307,48	99	438,38	441,17			
40	175,48	178,24	70	309,16	311,93	100	442,84	445,62			
41	179,92	182,71	71	313,61	316,40	101	447,30	450,09			
42	184,37	187,16	72	318,07	320,85	102	451,76	454,54			
43	188,83	191,61	73	322,53	325,30	103	456,21	459,00			
44	193,29	196,08	74	326,98	329,77	104	460,67	463,45			
45	197,75	200,53	75	331,44	334,22	105	465,13	467,90			
46	202,21	204,98	76	335,90	338,67	106	469,58	472,37			
47	206,65	209,43	77	340,34	343,12	107	474,03	476,82			
48	211,11	213,90	78	344,80	347,59	108	478,49	481,28			
49	215,57	218,35	79	349,26	352,04	109	482,95	485,74			
50	220,03	222,80	80	353,72	356,49	110	487,41	490,19			
51	224,49	227,27	81	358,17	360,96	111	491,87	494,64			
52	228,95	231,72	82	362,63	365,41	112	496,32	499,10			
53	233,39	236,18	83	367,09	369,86	113	500,78	503,55			
54	237,85	240,64	84	371,54	374,33	114	505,23	508,02			
55	242,30	245,09	85	376,00	378,78	116	514,14	516,93			
56	246,76	249,55	86	380,46	383,23	117	518,60	521,38			
57	251,22	254,01	87	384,91	387,70	118	523,06	525,83			

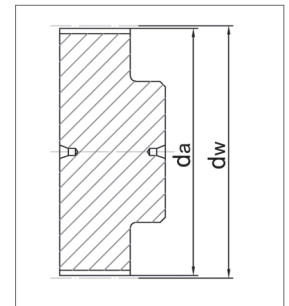

RTD 14M XHPL

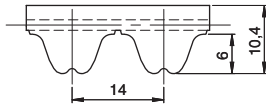

Belt characteristics

- Polyurethane timing belt with round tooth profile and high tensile load tension cords.
- Tooth profile according to ISO 13050
- Metric pitch 14 mm
- The round tooth profile allows a uniform load distribution that guarantees high performances, high transmissible torque and precise tooth engagement
- PAZ fabric on tooth side delivered as standard reduces noise in the drive
- **RTD14M - XHPL is the ideal belt for heavy duty synchronous lifting applications. Black colour as standard.**

- Width tolerance: $\pm 1,0$ [mm]
- Length tolerance: $\pm 0,5$ [mm/m]
- Thickness tolerance: $\pm 0,4$ [mm]

Technical Data

Belt width b [mm]	Allowable tensile load Type M F_{Tzul} [N]	Breaking load Type M F_{Br} [N]	Specific spring rate C_{spez} [N]	Weight [kg/m]
40	22000	77000	5500000	0,59
55	32000	112000	8000000	0,75
85	50000	175000	12500000	1,29
115	68000	238000	17000000	1,75
150	90000	315000	22500000	2,21

Other widths are available on request.

Load / Elongation [%]

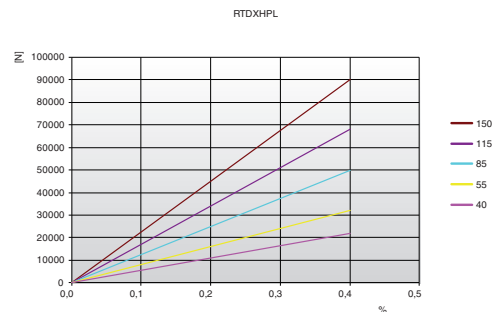

Tooth shear strength

rpm	F_{Uspez} [N/cm]	rpm	F_{Uspez} [N/cm]	rpm	F_{Uspez} [N/cm]	rpm	F_{Uspez} [N/cm]
0	140,00	800	93,80	1900	70,49	4000	48,24
20	137,31	900	90,85	2000	69,01	-	-
40	134,83	1000	88,14	2200	66,23	-	-
60	132,53	1100	85,63	2400	63,68	-	-
80	130,42	1200	83,31	2600	61,30	-	-
100	128,46	1300	81,14	2800	59,09	-	-
200	119,77	1400	79,11	2880	58,24	-	-
300	114,29	1440	78,33	3000	57,01	-	-
400	109,19	1500	77,19	3200	55,06	-	-
500	104,65	1600	75,38	3400	53,22	-	-
600	100,64	1700	73,67	3600	51,48	-	-
700	97,04	1800	72,04	3800	49,82	-	-

Tooth shear strength / rpm

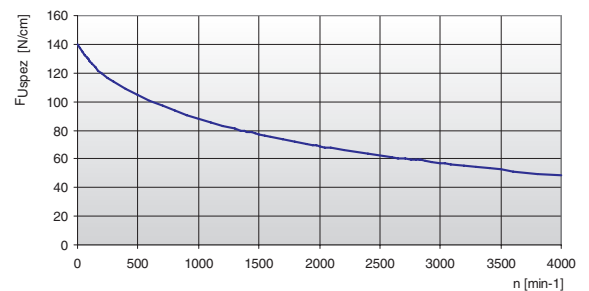

The specific load F_{Uspez} is the maximum load which one single belt tooth 1 cm wide can withstand in all operating conditions. This force is related to the drive rpm.

The total load F_u transmissible by the belt in the drive is calculated by:

$$F_u [N] = F_{Uspez} \cdot Z_e \cdot b$$

- $F_u [N]$ = peripheral force
- $F_{Uspez} [N/cm]$ = specific load
- Z_e = number of teeth in mesh in the small pulley
- Z_{emax} = max. no of teeth in mesh to be considered for the calculation of the drive
- Z_{emax} = 12 for ELATECH® M
- Z_{emax} = 6 for ELATECH® V
- $b [cm]$ = belt width in cm

RTD 14M XHPL

Flexibility

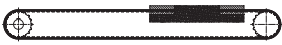
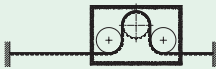
Minimum pulley number of teeth and minimum idler diameter		Type of cord
		STANDARD
Drive without reverse bending 	Timing pulley z_{min}	34
	Flat idler running on belt teeth d_{min}	140 mm
Drive with reverse bending 	Timing pulley z_{min}	34
	Flat idler running on belt back d_{min}	250 mm

Timing pulleys

z	da	dw	z	da	dw	z	da	dw	z	da	dw
28	122,12	124,77	58	255,68	258,46	88	389,37	392,15	119	527,51	530,30
29	126,58	129,22	59	260,14	262,91	89	393,83	396,60	120	531,97	534,75
30	130,99	133,69	60	264,60	267,38	90	398,29	401,07			
31	135,45	138,14	61	269,04	271,83	91	402,73	405,52			
32	139,88	142,59	62	273,50	276,28	92	407,19	409,97			
33	144,35	147,06	63	277,96	280,75	93	411,65	414,44			
34	148,79	151,51	64	282,42	285,20	94	416,10	418,89			
35	153,25	155,96	65	286,88	289,65	95	420,56	423,35			
36	157,68	160,41	66	291,32	294,11	96	425,02	427,80			
37	162,14	164,88	67	295,78	298,56	97	429,48	432,25			
38	166,60	169,34	68	300,24	303,03	98	433,94	436,72			
39	171,02	173,79	69	304,70	307,48	99	438,38	441,17			
40	175,48	178,24	70	309,16	311,93	100	442,84	445,62			
41	179,92	182,71	71	313,61	316,40	101	447,30	450,09			
42	184,37	187,16	72	318,07	320,85	102	451,76	454,54			
43	188,83	191,61	73	322,53	325,30	103	456,21	459,00			
44	193,29	196,08	74	326,98	329,77	104	460,67	463,45			
45	197,75	200,53	75	331,44	334,22	105	465,13	467,90			
46	202,21	204,98	76	335,90	338,67	106	469,58	472,37			
47	206,65	209,43	77	340,34	343,12	107	474,03	476,82			
48	211,11	213,90	78	344,80	347,59	108	478,49	481,28			
49	215,57	218,35	79	349,26	352,04	109	482,95	485,74			
50	220,03	222,80	80	353,72	356,49	110	487,41	490,19			
51	224,49	227,27	81	358,17	360,96	111	491,87	494,64			
52	228,95	231,72	82	362,63	365,41	112	496,32	499,10			
53	233,39	236,18	83	367,09	369,86	113	500,78	503,55			
54	237,85	240,64	84	371,54	374,33	114	505,23	508,02			
55	242,30	245,09	85	376,00	378,78	116	514,14	516,93			
56	246,76	249,55	86	380,46	383,23	117	518,60	521,38			
57	251,22	254,01	87	384,91	387,70	118	523,06	525,83			

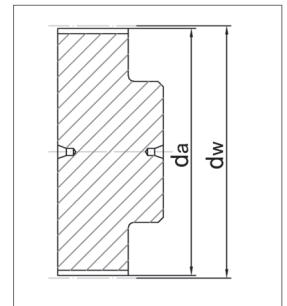

Note

Special pulley profile required.
Contact ELATECH Technical Dept. for details.

STD 5M

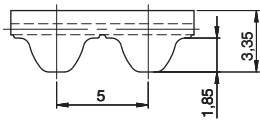

Belt characteristics

- Polyurethane timing belt with involute tooth, high tensile load steel cords and high torque capacity
- Tooth profile according to ISO 13050
- Metric pitch 5 mm
- Low noise generation in high speed drives
- Offers excellent operational reliability in linear positioning and light power transmission applications
- The special profile allows smooth running properties

- Width tolerance: $\pm 0,5$ [mm]
- Length tolerance: $\pm 0,5$ [mm/m]
- Thickness tolerance: $\pm 0,2$ [mm]

Technical Data

Belt width b [mm]	Allowable tensile load Type M F_{Tzul} [N]	Allowable tensile load Type V F_{Tzul} [N]	Breaking load Type M F_{Br} [N]	Specific spring rate C_{spez} [N]	Weight [kg/m]
10	920	460	3360	230000	0,05
15	1500	750	5460	375000	0,07
25	2650	1325	9660	662500	0,12
50	5520	2760	20160	1380000	0,23
100	11270	5635	41160	2817500	0,46

Other widths are available on request.

Load / Elongation [%]

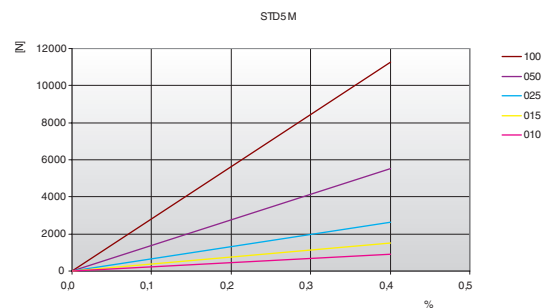

Tooth shear strength

rpm	F_{Uspez} [N/cm]	rpm	F_{Uspez} [N/cm]	rpm	F_{Uspez} [N/cm]	rpm	F_{Uspez} [N/cm]
0	36,90	800	27,71	1900	22,74	4500	16,90
20	36,35	900	27,11	2000	22,41	5000	16,14
40	35,85	1000	26,55	2200	21,80	5500	15,45
60	35,40	1100	26,02	2400	21,22	6000	14,82
80	34,99	1200	25,53	2600	20,69	6500	14,24
100	34,62	1300	25,06	2800	20,19	7000	13,69
200	33,23	1400	24,63	3000	19,73	7500	13,18
300	31,37	1440	24,46	3200	19,28	8000	12,70
400	30,60	1500	24,21	3400	18,87	8500	12,25
500	29,81	1600	23,82	3600	18,47	9000	11,83
600	29,06	1700	23,44	3800	18,09	9500	11,42
700	28,36	1800	23,08	4000	17,73	10000	11,03

Tooth shear strength / rpm

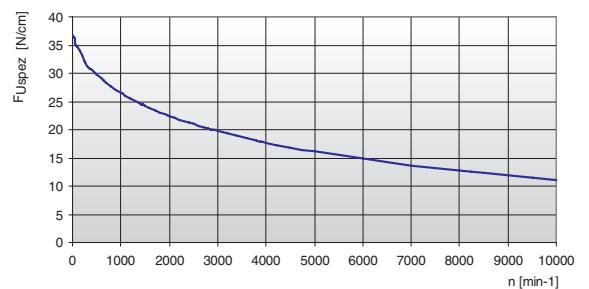

The specific load F_{Uspez} is the maximum load which one single belt tooth 1 cm wide can withstand in all operating conditions.

This force is related to the drive rpm.

The total load F_u transmissible by the belt in the drive is calculated by:

$$F_u [N] = F_{Uspez} \cdot Z_e \cdot b$$

- F_u [N] = peripheral force
- F_{Uspez} [N/cm] = specific load
- Z_e = number of teeth in mesh in the small pulley
- Z_{emax} = max. no of teeth in mesh to be considered for the calculation of the drive
- Z_{emax} = 12 for ELATECH® M
- Z_{emax} = 6 for ELATECH® V
- b [cm] = belt width in cm

STD 5M

Specialties

Belt width b [mm]	ARAMID CORD		STAINLESS STEEL		HFE High Flexibility	
	F _{Tzul} [N] M type	F _{Br} [N]	F _{Tzul} [N] M type	F _{Br} [N]	F _{Tzul} [N] M type	F _{Br} [N]
10	880	3600	600	2400	960	3440
15	1430	5850	980	3900	1560	5590
25	2530	10350	1730	6900	2760	9890
50	5280	21600	3600	14400	5760	20640
100	10780	44100	-	-	-	-

Flexibility

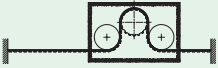
Minimum pulley number of teeth and minimum idler diameter		Type of cord			
		STANDARD	ARAMID	STAINLESS	HFE
Drive without reverse bending 	Timing pulley z _{min}	16	16	18	15
	Flat idler running on belt teeth d _{min}	30 mm	30 mm	40 mm	40 mm
Drive with reverse bending 	Timing pulley z _{min}	25	25	25	20
	Flat idler running on belt back d _{min}	60 mm	60 mm	65 mm	40 mm

Timing pulleys

z	da	dw	z	da	dw	z	da	dw	z	da	dw
10	14,95	15,91	40	62,70	63,66	70	110,45	111,41	100	158,19	159,15
11	16,54	17,50	41	64,30	65,26	71	112,04	113,00	101	159,79	160,75
12	18,14	19,10	42	65,89	66,85	72	113,63	114,59	102	161,38	162,34
13	19,73	20,69	43	67,48	68,44	73	115,23	116,19	103	162,99	163,95
14	21,32	22,28	44	69,07	70,03	74	116,82	117,78	104	164,56	165,52
15	22,91	23,87	45	70,66	71,62	75	118,41	119,37	105	166,15	167,11
16	24,51	25,47	46	72,25	73,21	76	120,00	120,96	106	167,74	168,70
17	26,10	27,06	47	73,84	74,80	77	121,59	122,55	107	169,34	170,3
18	27,69	28,65	48	75,43	76,39	78	123,18	124,14	108	170,93	171,89
19	29,27	30,23	49	77,03	77,99	79	124,77	125,73	109	172,52	173,48
20	30,87	31,83	50	78,62	79,58	80	126,36	127,32	110	174,10	175,06
21	32,46	33,42	51	80,21	81,17	81	127,95	128,91	111	175,7	176,66
22	34,05	35,01	52	81,80	82,76	82	129,54	130,50	112	177,29	178,25
23	35,65	36,61	53	83,39	84,35	83	131,14	132,10	113	178,88	179,84
24	37,23	38,19	54	84,99	85,95	84	132,73	133,69	114	180,47	181,43
25	38,83	39,79	55	86,58	87,54	85	134,32	135,28	115	182,06	183,02
26	40,42	41,38	56	88,17	89,13	86	135,91	136,87	116	183,65	184,61
27	42,01	42,97	57	89,76	90,72	87	137,51	138,47	117	185,25	186,21
28	43,60	44,56	58	91,35	92,31	88	139,09	140,05	118	186,84	187,8
29	45,19	46,15	59	92,94	93,90	89	140,69	141,65	119	188,43	189,39
30	46,79	47,75	60	94,53	95,49	90	142,28	143,24	120	190,02	190,98
31	48,38	49,34	61	96,13	97,09	91	143,87	144,83			
32	49,97	50,93	62	97,72	98,68	92	145,46	146,42			
33	51,56	52,52	63	99,31	100,27	93	147,05	148,01			
34	53,15	54,11	64	100,90	101,86	94	148,64	149,60			
35	54,75	55,71	65	102,49	103,45	95	150,24	151,20			
36	56,34	57,30	66	104,08	105,04	96	151,83	152,71			
37	57,93	58,89	67	105,67	106,63	97	153,42	154,38			
38	59,52	60,48	68	107,27	108,23	98	155,01	155,97			
39	61,11	62,07	69	108,86	109,82	99	156,60	157,56			

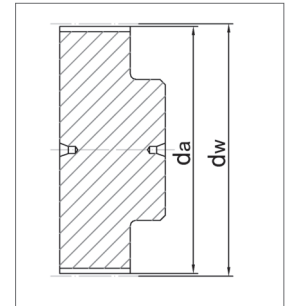

STD 8M

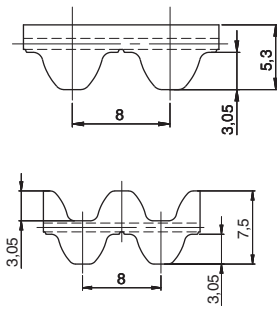

Belt characteristics

- Polyurethane timing belt with involute tooth, high tensile load steel cords and high torque capacity
- Tooth profile according to ISO 13050
- Metric pitch 8 mm
- Low noise generation in high speed drives
- Offers excellent operational reliability in linear positioning and medium power transmission applications
- Widely used in automatic doors
- The special profile allows smooth running properties

- Width tolerance: $\pm 0,5$ [mm]
- Length tolerance: $\pm 0,5$ [mm/m]
- Thickness tolerance: $\pm 0,2$ [mm]

Technical Data

Belt width b [mm]	Allowable tensile load Type M F_{Tzul} [N]	Allowable tensile load Type V F_{Tzul} [N]	Breaking load Type M F_{Br} [N]	Specific spring rate C_{spez} [N]	Weight [kg/m]
10	1470	735	5700	367500	0,07
15	2210	1105	8550	552500	0,10
20	3190	1595	12350	797500	0,13
30	4660	2330	18050	1165000	0,20
50	8580	4290	33250	2145000	0,33
85	14700	7350	57000	3675000	0,56
100	17400	8700	67450	4350000	0,66

Other widths are available on request.

Load / Elongation [%]

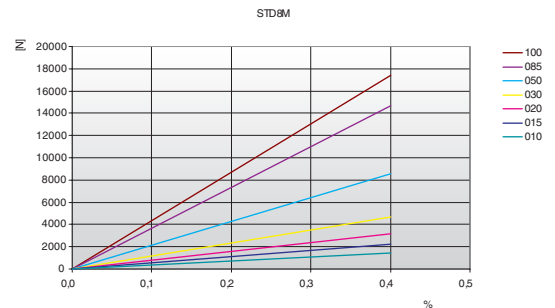

Tooth shear strength

rpm	F_{Uspez} [N/cm]	rpm	F_{Uspez} [N/cm]	rpm	F_{Uspez} [N/cm]	rpm	F_{Uspez} [N/cm]
0	74,10	800	51,53	1900	39,76	4500	26,79
20	73,05	900	50,03	2000	39,02	5000	25,14
40	72,06	1000	48,66	2200	37,62	5500	23,65
60	71,13	1100	47,39	2400	36,34	6000	22,28
80	70,26	1200	46,22	2600	35,15	-	-
100	69,43	1300	45,12	2800	34,04	-	-
200	65,98	1400	44,10	3000	33,00	-	-
300	62,11	1440	43,70	3200	32,02	-	-
400	59,43	1500	43,13	3400	31,10	-	-
500	57,08	1600	42,22	3600	30,23	-	-
600	55,02	1700	41,36	3800	29,40	-	-
700	53,18	1800	40,54	4000	28,61	-	-

Tooth shear strength / rpm

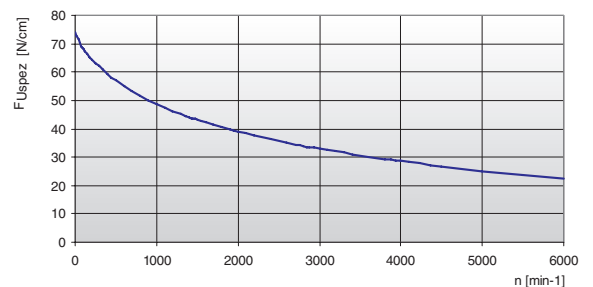

The specific load F_{Uspez} is the maximum load which one single belt tooth 1 cm wide can withstand in all operating conditions. This force is related to the drive rpm. The total load F_u transmissible by the belt in the drive is calculated by:

$$F_u [N] = F_{Uspez} \cdot Z_e \cdot b$$

- F_u [N] = peripheral force
- F_{Uspez} [N/cm] = specific load
- Z_e = number of teeth in mesh in the small pulley
- Z_{emax} = max. no of teeth in mesh to be considered for the calculation of the drive
- Z_{emax} = 12 for ELATECH® M
- Z_{emax} = 6 for ELATECH® V
- b [cm] = belt width in cm

STD 8M

Specialties

Belt width b [mm]	ARAMID CORD		STAINLESS STEEL		HPL High Performance	
	F _{Tzul} [N] M type	F _{Br} [N]	F _{Tzul} [N] M type	F _{Br} [N]	F _{Tzul} [N] M type	F _{Br} [N]
10	1140	4740	1080	4500	-	-
15	1710	7110	1620	6750	-	-
20	2470	10270	2340	9750	5280	19250
30	3800	15800	3600	15000	8160	29750
50	6650	27650	6300	26250	14400	52500
85	11400	47400	10800	45000	24480	89250
100	13500	56000	12780	53250	29280	106750

Flexibility

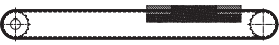
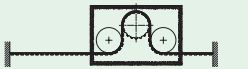
Minimum pulley number of teeth and minimum idler diameter		Type of cord			
		STANDARD	ARAMID	STAINLESS	HPL
Drive without reverse bending 	Timing pulley z _{min}	18	18	24	30
	Flat idler running on belt teeth d _{min}	50 mm	50 mm	70 mm	80 mm
Drive with reverse bending 	Timing pulley z _{min}	30	30	40	30
	Flat idler running on belt back d _{min}	120 mm	120 mm	120 mm	150 mm

Timing pulleys

z	da	dw	z	da	dw	z	da	dw	z	da	dw
18	44,46	45,83	48	120,86	122,23	78	197,25	198,62	108	273,64	275,01
19	47,01	48,38	49	123,40	124,77	79	199,80	201,17	109	276,19	277,56
20	49,56	50,93	50	125,95	127,32	80	202,35	203,72	110	278,74	280,11
21	52,10	53,47	51	128,50	129,87	81	204,89	206,26	111	281,29	282,66
22	54,65	56,02	52	131,05	132,41	82	207,44	208,81	112	283,84	285,21
23	57,20	58,57	53	133,59	134,96	83	209,98	211,35	113	286,38	287,75
24	59,75	61,12	54	136,14	137,51	84	212,53	213,90	114	288,93	290,30
25	62,29	63,66	55	138,68	140,05	85	215,08	216,45	115	291,47	292,84
26	64,84	66,21	56	141,23	142,60	86	217,63	219,00	116	294,02	295,39
27	67,38	68,75	57	143,78	145,15	87	220,17	221,54	117	296,57	297,94
28	70,08	71,30	58	146,32	147,69	88	222,72	224,09	118	299,11	300,48
29	72,59	73,84	59	148,87	150,24	89	225,26	226,63	119	301,66	303,03
30	75,13	76,39	60	151,42	152,79	90	227,81	229,18	120	304,20	305,57
31	77,65	78,94	61	153,96	155,33	91	230,35	231,72			
32	80,16	81,49	62	156,52	157,89	92	232,90	234,27			
33	82,68	84,03	63	159,06	160,43	93	235,45	236,82			
34	85,21	86,58	64	161,60	162,97	94	238,00	239,37			
35	87,76	89,12	65	164,15	165,52	95	240,54	241,91			
36	90,30	91,67	66	166,69	168,06	96	243,09	244,46			
37	92,85	94,22	67	169,24	170,61	97	245,63	247,00			
38	95,40	96,77	68	171,79	173,16	98	248,18	249,55			
39	97,94	99,31	69	174,33	175,70	99	250,73	252,10			
40	100,49	101,86	70	176,88	178,25	100	253,28	254,67			
41	103,04	104,40	71	179,43	180,8	101	255,82	257,19			
42	105,58	106,95	72	181,98	183,35	102	258,37	259,74			
43	108,13	109,50	73	184,52	185,89	103	260,91	262,28			
44	110,68	112,05	74	187,07	188,44	104	263,46	264,83			
45	113,22	114,59	75	189,61	190,98	105	266,01	267,38			
46	115,77	117,14	76	192,16	193,53	106	268,55	269,92			
47	118,31	119,68	77	194,71	196,08	107	271,10	272,47			

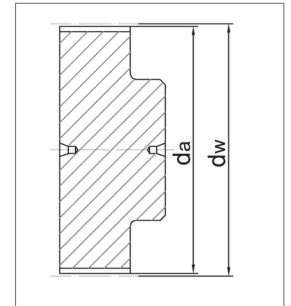

STD 14M

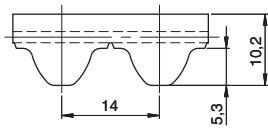

Belt characteristics

- Polyurethane timing belt with involute tooth, high tensile load steel cords and high torque capacity
- Tooth profile according to ISO 13050
- Metric pitch 14 mm
- Low noise generation in high speed drives
- Tension cords with increased tensile load for lower elongation
- Superior performance in lifting applications
- The special profile allows smooth running properties

- Width tolerance: $\pm 1,0$ [mm]
- Length tolerance: $\pm 0,5$ [mm/m]
- Thickness tolerance: $\pm 0,4$ [mm]

Technical Data

Belt width b [mm]	Allowable tensile load Type M F_{Tzul} [N]	Allowable tensile load Type V F_{Tzul} [N]	Breaking load Type M F_{Br} [N]	Specific spring rate C_{spez} [N]	Weight [kg/m]
40	12750	6375	48000	3187500	0,50
55	17850	8925	67200	4462500	0,70
85	28050	14025	105600	7012500	1,08
115	39100	19550	147200	9775000	1,48

Other widths are available on request.

Load / Elongation [%]

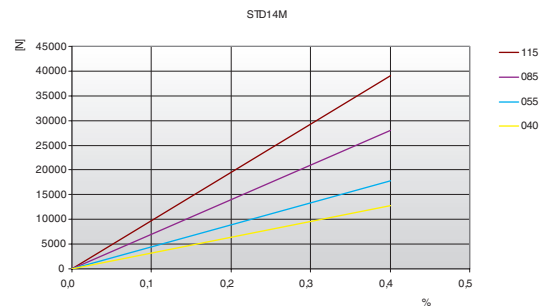

Tooth shear strength

rpm	F_{Uspez} [N/cm]	rpm	F_{Uspez} [N/cm]	rpm	F_{Uspez} [N/cm]	rpm	F_{Uspez} [N/cm]
0	134,00	800	88,80	1900	65,49	4000	43,24
20	131,31	900	85,85	2000	64,01	-	-
40	128,83	1000	83,14	2200	61,23	-	-
60	126,53	1100	80,63	2400	58,68	-	-
80	124,42	1200	78,31	2600	56,30	-	-
100	122,46	1300	76,14	2800	54,09	-	-
200	114,77	1400	74,11	2880	53,24	-	-
300	109,29	1440	73,33	3000	52,01	-	-
400	104,19	1500	72,19	3200	50,06	-	-
500	99,65	1600	70,38	3400	48,22	-	-
600	95,64	1700	68,67	3600	46,48	-	-
700	92,04	1800	67,04	3800	44,82	-	-

Tooth shear strength / rpm

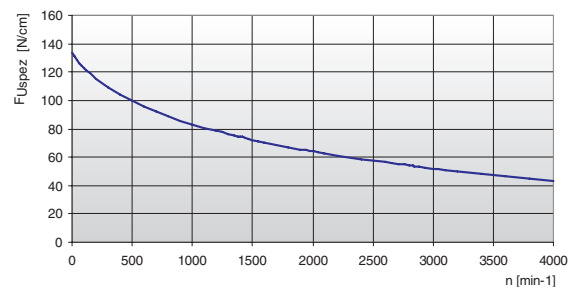

The specific load F_{Uspez} is the maximum load which one single belt tooth 1 cm wide can withstand in all operating conditions.

This force is related to the drive rpm.

The total load F_u transmissible by the belt in the drive is calculated by:

$$F_u [N] = F_{Uspez} \cdot Z_e \cdot b$$

- F_u [N] = peripheral force
- F_{Uspez} [N/cm] = specific load
- Z_e = number of teeth in mesh in the small pulley
- Z_{emax} = max. no of teeth in mesh to be considered for the calculation of the drive
- Z_{emax} = 12 for ELATECH® M
- Z_{emax} = 6 for ELATECH® V
- b [cm] = belt width in cm

STD 14M

Flexibility

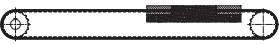
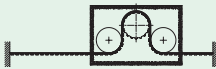
Minimum pulley number of teeth and minimum idler diameter		Type of cord
		STANDARD
Drive without reverse bending 	Timing pulley z_{min}	32
	Flat idler running on belt teeth d_{min}	140 mm
Drive with reverse bending 	Timing pulley z_{min}	32
	Flat idler running on belt back d_{min}	250 mm

Timing pulleys

z	da	dw	z	da	dw	z	da	dw	z	da	dw
28	122,12	124,77	58	255,68	258,46	88	389,37	392,15	119	527,51	530,30
29	126,58	129,22	59	260,14	262,91	89	393,83	396,60	120	531,97	534,75
30	130,99	133,69	60	264,60	267,38	90	398,29	401,07			
31	135,45	138,14	61	269,04	271,83	91	402,73	405,52			
32	139,88	142,59	62	273,50	276,28	92	407,19	409,97			
33	144,35	147,06	63	277,96	280,75	93	411,65	414,44			
34	148,79	151,51	64	282,42	285,20	94	416,10	418,89			
35	153,25	155,96	65	286,88	289,65	95	420,56	423,35			
36	157,68	160,41	66	291,32	294,11	96	425,02	427,80			
37	162,14	164,88	67	295,78	298,56	97	429,48	432,25			
38	166,60	169,34	68	300,24	303,03	98	433,94	436,72			
39	171,02	173,79	69	304,70	307,48	99	438,38	441,17			
40	175,48	178,24	70	309,16	311,93	100	442,84	445,62			
41	179,92	182,71	71	313,61	316,40	101	447,30	450,09			
42	184,37	187,16	72	318,07	320,85	102	451,76	454,54			
43	188,83	191,61	73	322,53	325,30	103	456,21	459,00			
44	193,29	196,08	74	326,98	329,77	104	460,67	463,45			
45	197,75	200,53	75	331,44	334,22	105	465,13	467,90			
46	202,21	204,98	76	335,90	338,67	106	469,58	472,37			
47	206,65	209,43	77	340,34	343,12	107	474,03	476,82			
48	211,11	213,90	78	344,80	347,59	108	478,49	481,28			
49	215,57	218,35	79	349,26	352,04	109	482,95	485,74			
50	220,03	222,80	80	353,72	356,49	110	487,41	490,19			
51	224,49	227,27	81	358,17	360,96	111	491,87	494,64			
52	228,95	231,72	82	362,63	365,41	112	496,32	499,10			
53	233,39	236,18	83	367,09	369,86	113	500,78	503,55			
54	237,85	240,64	84	371,54	374,33	114	505,23	508,02			
55	242,30	245,09	85	376,00	378,78	116	514,14	516,93			
56	246,76	249,55	86	380,46	383,23	117	518,60	521,38			
57	251,22	254,01	87	384,91	387,70	118	523,06	525,83			

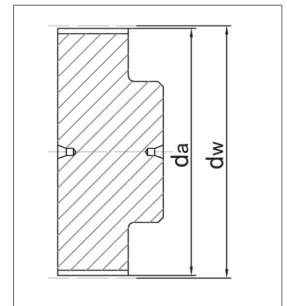

EAGLE 5M

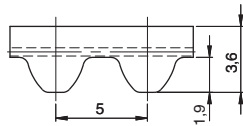

Belt characteristics

- Polyurethane timing belt with helical offset tooth, high tensile load steel cords and high torque capacity
- **Self tracking no need of pulley flanges**
- Metric pitch 5 mm
- **Extremely reduced noise generation**
- Offers excellent operational reliability in linear positioning and medium power transmission applications
- The special profile allows most compact drive

- Width tolerance: $\pm 0,5$ [mm]
- Length tolerance: $\pm 0,5$ [mm/m]
- Thickness tolerance: $\pm 0,2$ [mm]

Technical Data

Belt width b [mm]	Allowable tensile load Type M F_{Tzul} [N]	Allowable tensile load Type V F_{Tzul} [N]	Breaking load Type M F_{Br} [N]	Specific spring rate C_{spez} [N]	Weight [kg/m]
12,5	1150	575	4200	287500	0,06
25	2530	1265	9240	632500	0,12

Other widths are available on request.

Load / Elongation [%]

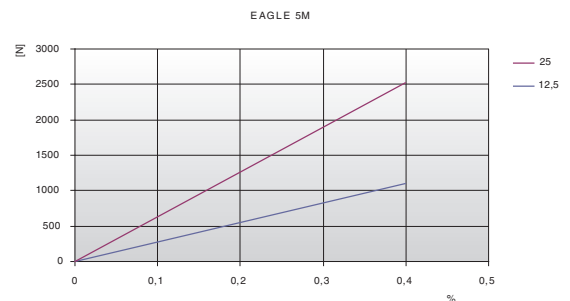

Tooth shear strength

rpm	F_{Uspez} [N/cm]	rpm	F_{Uspez} [N/cm]	rpm	F_{Uspez} [N/cm]	rpm	F_{Uspez} [N/cm]
0	37,80	900	28,61	2200	23,30	5500	16,95
20	37,25	1000	28,05	2400	22,72	6000	16,32
40	36,75	1100	27,52	2600	22,19	6500	15,74
60	36,30	1200	27,03	2800	21,69	7000	15,19
80	35,89	1300	26,56	2880	21,50	7500	14,68
100	35,52	1400	26,13	3000	21,23	8000	14,20
200	34,13	1440	25,96	3200	20,78	8500	13,75
300	32,87	1500	25,71	3400	20,37	9000	13,33
400	32,10	1600	25,32	3600	19,97	9500	12,92
500	31,31	1700	24,94	3800	19,59	10000	12,53
600	30,56	1800	24,58	4000	19,23	-	-
700	29,86	1900	24,24	4500	18,40	-	-
800	29,21	2000	23,91	5000	17,64	-	-

Tooth shear strength / rpm

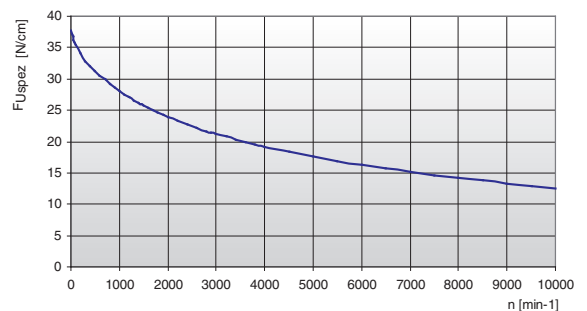

The specific load F_{Uspez} is the maximum load which one single belt tooth 1 cm wide can withstand in all operating conditions. This force is related to the drive rpm.



The total load F_u transmissible by the belt in the drive is calculated by:

$$F_u [N] = F_{Uspez} \cdot Z_e \cdot b$$

- F_u [N] = peripheral force
- F_{Uspez} [N/cm] = specific load
- Z_e = number of teeth in mesh in the small pulley
- Z_{emax} = max. no of teeth in mesh to be considered for the calculation of the drive
- Z_{emax} = 12 for ELATECH® M
- Z_{emax} = 6 for ELATECH® V
- b [cm] = belt width in cm

EAGLE 5M

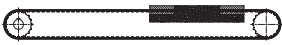
Flexibility

Minimum pulley number of teeth and minimum idler diameter		Type of cord
		STANDARD
Drive without reverse bending 	Timing pulley z_{min}	16
	Flat idler running on belt teeth d_{min}	30 mm
Drive with reverse bending 	Timing pulley z_{min}	25
	Flat idler running on belt back d_{min}	60 mm

Timing pulleys

z	da	dw	z	da	dw	z	da	dw	z	da	dw
10	14,95	15,91	40	62,70	63,66	70	110,45	111,41	100	158,19	159,15
11	16,54	17,50	41	64,30	65,26	71	112,04	113,00	101	159,79	160,75
12	18,14	19,10	42	65,89	66,85	72	113,63	114,59	102	161,38	162,34
13	19,73	20,69	43	67,48	68,44	73	115,23	116,19	103	162,99	163,95
14	21,32	22,28	44	69,07	70,03	74	116,82	117,78	104	164,56	165,52
15	22,91	23,87	45	70,66	71,62	75	118,41	119,37	105	166,15	167,11
16	24,51	25,47	46	72,25	73,21	76	120,00	120,96	106	167,74	168,70
17	26,10	27,06	47	73,84	74,80	77	121,59	122,55	107	169,34	170,30
18	27,69	28,65	48	75,43	76,39	78	123,18	124,14	108	170,93	171,89
19	29,27	30,23	49	77,03	77,99	79	124,77	125,73	109	172,52	173,48
20	30,87	31,83	50	78,62	79,58	80	126,36	127,32	110	174,1	175,06
21	32,46	33,42	51	80,21	81,17	81	127,95	128,91	111	175,7	176,66
22	34,05	35,01	52	81,80	82,76	82	129,54	130,50	112	177,29	178,25
23	35,65	36,61	53	83,39	84,35	83	131,14	132,10	113	178,88	179,84
24	37,23	38,19	54	84,99	85,95	84	132,73	133,69	114	180,47	181,43
25	38,83	39,79	55	86,58	87,54	85	134,32	135,28	115	182,06	183,02
26	40,42	41,38	56	88,17	89,13	86	135,91	136,87	116	183,65	184,61
27	42,01	42,97	57	89,76	90,72	87	137,51	138,47	117	185,25	186,21
28	43,60	44,56	58	91,35	92,31	88	139,09	140,05	118	186,84	187,8
29	45,19	46,15	59	92,94	93,90	89	140,69	141,65	119	188,43	189,39
30	46,79	47,75	60	94,53	95,49	90	142,28	143,24	120	190,02	190,98
31	48,38	49,34	61	96,13	97,09	91	143,87	144,83			
32	49,97	50,93	62	97,72	98,68	92	145,46	146,42			
33	51,56	52,52	63	99,31	100,27	93	147,05	148,01			
34	53,15	54,11	64	100,90	101,86	94	148,64	149,60			
35	54,75	55,71	65	102,49	103,45	95	150,24	151,20			
36	56,34	57,30	66	104,08	105,04	96	151,83	152,71			
37	57,93	58,89	67	105,67	106,63	97	153,42	154,38			
38	59,52	60,48	68	107,27	108,23	98	155,01	155,97			
39	61,11	62,07	69	108,86	109,82	99	156,60	157,56			

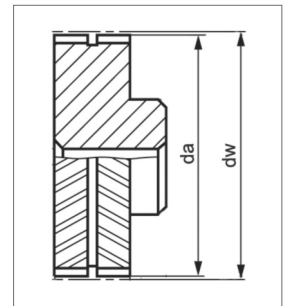

EAGLE 8M

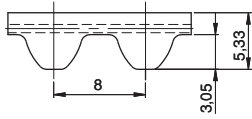

Belt characteristics

- Polyurethane timing belt with helical offset tooth, high tensile load steel cords and high torque capacity
- **Self tracking no need of pulley flanges**
- Metric pitch 8 mm
- **Extremely reduced noise generation**
- Offers excellent operational reliability in linear positioning and medium power transmission applications
- The special profile allows most compact drive

- Width tolerance: $\pm 0,8$ [mm]
- Length tolerance: $\pm 0,8$ [mm/m]
- Thickness tolerance: $\pm 0,3$ [mm]

Technical Data

Belt width b [mm]	Allowable tensile load Type M F_{Tzul} [N]	Allowable tensile load Type V F_{Tzul} [N]	Breaking load Type M F_{Br} [N]	Specific spring rate C_{spez} [N]	Weight [kg/m]
16	2450	1200	9500	612500	0,085
25	4170	2100	16150	1042500	0,145
32	5390	2700	20900	1347500	0,180
50	8580	4300	33250	2145000	0,300

Other widths are available on request.

Load / Elongation [%]

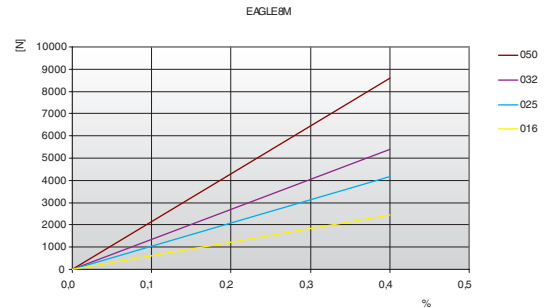

Tooth shear strength

rpm	F_{Uspez} [N/cm]	rpm	F_{Uspez} [N/cm]	rpm	F_{Uspez} [N/cm]	rpm	F_{Uspez} [N/cm]
0	85,00	800	59,66	1900	46,95	4500	32,75
20	83,78	900	58,05	2000	46,14	5000	30,94
40	82,62	1000	56,58	2200	44,62	5500	29,30
60	81,49	1100	55,22	2400	43,22	6000	27,79
80	80,42	1200	53,95	2600	41,91	6500	26,40
100	79,38	1300	52,77	2800	40,70	7000	25,11
200	74,78	1400	51,66	3000	39,56	7500	23,90
300	71,01	1440	51,23	3200	38,49	8000	22,77
400	67,93	1500	50,61	3400	37,48	8500	21,70
500	65,52	1600	49,62	3600	36,52	9000	20,69
600	63,36	1700	48,69	3800	35,61	9500	19,73
700	61,42	1800	47,80	4000	34,75	10000	18,82

Tooth shear strength / rpm

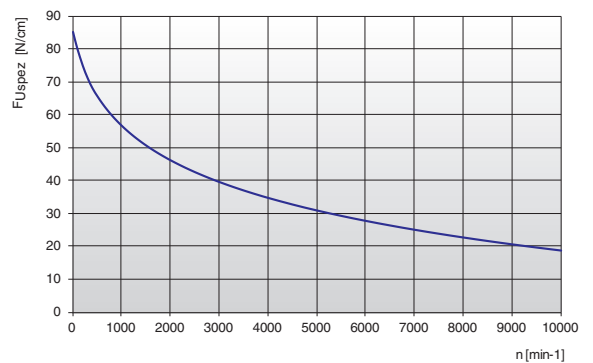

The specific load F_{Uspez} is the maximum load which one single belt tooth 1 cm wide can withstand in all operating conditions.

This force is related to the drive rpm.

The total load F_u transmissible by the belt in the drive is calculated by:

$$F_u [N] = F_{Uspez} \cdot Z_e \cdot b$$

- F_u [N] = peripheral force
- F_{Uspez} [N/cm] = specific load
- Z_e = number of teeth in mesh in the small pulley
- Z_{emax} = max. no of teeth in mesh to be considered for the calculation of the drive
- Z_{emax} = 12 for ELATECH® M
- Z_{emax} = 6 for ELATECH® V
- b [cm] = belt width in cm

EAGLE 8M

Specialties

Belt width b [mm]	ARAMID CORD		STAINLESS STEEL		HPL High Performance	
	F _{Tzul} [N] M type	F _{Br} [N]	F _{Tzul} [N] M type	F _{Br} [N]	F _{Tzul} [N] M type	F _{Br} [N]
16	1800	7500	1800	7500	3840	14000
25	3060	12750	3060	12750	6720	24500
32	3960	16500	3960	16500	8640	31500
50	6300	26250	6300	26250	14400	52500

Flexibility

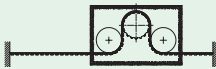
Minimum pulley number of teeth and minimum idler diameter		Type of cord		
		STANDARD	STAINLESS	HPL
Drive without reverse bending 	Timing pulley z _{min}	20	24	30
	Flat idler running on belt teeth d _{min}	50 mm	70 mm	80 mm
Drive with reverse bending 	Timing pulley z _{min}	30	40	30
	Flat idler running on belt back d _{min}	120 mm	120 mm	150 mm

Timing pulleys

z	da	dw	z	da	dw	z	da	dw	z	da	dw
18	44,46	45,83	48	120,86	122,23	78	197,25	198,62	108	273,64	275,01
19	47,01	48,38	49	123,40	124,77	79	199,80	201,17	109	276,19	277,56
20	49,56	50,93	50	125,95	127,32	80	202,35	203,72	110	278,74	280,11
21	52,10	53,47	51	128,50	129,87	81	204,89	206,26	111	281,29	282,66
22	54,65	56,02	52	131,05	132,41	82	207,44	208,81	112	283,84	285,21
23	57,20	58,57	53	133,59	134,96	83	209,98	211,35	113	286,38	287,75
24	59,75	61,12	54	136,14	137,51	84	212,53	213,90	114	288,93	290,30
25	62,29	63,66	55	138,68	140,05	85	215,08	216,45	115	291,47	292,84
26	64,84	66,21	56	141,23	142,60	86	217,63	219,00	116	294,02	295,39
27	67,38	68,75	57	143,78	145,15	87	220,17	221,54	117	296,57	297,94
28	70,08	71,30	58	146,32	147,69	88	222,72	224,09	118	299,11	300,48
29	72,59	73,84	59	148,87	150,24	89	225,26	226,63	119	301,66	303,03
30	75,13	76,39	60	151,42	152,79	90	227,81	229,18	120	304,2	305,57
31	77,65	78,94	61	153,96	155,33	91	230,35	231,72			
32	80,16	81,49	62	156,52	157,89	92	232,90	234,27			
33	82,68	84,03	63	159,06	160,43	93	235,45	236,82			
34	85,21	86,58	64	161,6	162,97	94	238,00	239,37			
35	87,76	89,12	65	164,15	165,52	95	240,54	241,91			
36	90,30	91,67	66	166,69	168,06	96	243,09	244,46			
37	92,85	94,22	67	169,24	170,61	97	245,63	247,00			
38	95,40	96,77	68	171,79	173,16	98	248,18	249,55			
39	97,94	99,31	69	174,33	175,70	99	250,73	252,10			
40	100,49	101,86	70	176,88	178,25	100	253,28	254,67			
41	103,04	104,40	71	179,43	180,80	101	255,82	257,19			
42	105,58	106,95	72	181,98	183,35	102	258,37	259,74			
43	108,13	109,50	73	184,52	185,89	103	260,91	262,28			
44	110,68	112,05	74	187,07	188,44	104	263,46	264,83			
45	113,22	114,59	75	189,61	190,98	105	266,01	267,38			
46	115,77	117,14	76	192,16	193,53	106	268,55	269,92			
47	118,31	119,68	77	194,71	196,08	107	271,1	272,47			

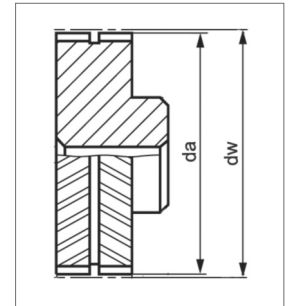

EAGLE 10M

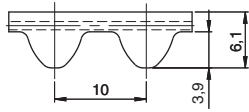

Belt characteristics

- Polyurethane timing belt with helical offset tooth, high tensile load steel cords and high torque capacity
- **Self tracking no need of pulley flanges**
- Metric pitch 10 mm
- **Extremely reduced noise generation**
- Offers excellent operational reliability in linear positioning and medium power transmission applications
- The special profile allows most compact drive

- Width tolerance: $\pm 0,8$ [mm]
- Length tolerance: $\pm 0,8$ [mm/m]
- Thickness tolerance: $\pm 0,3$ [mm]

Technical Data

Belt width b [mm]	Allowable tensile load Type M F_{Tzul} [N]	Breaking load Type M F_{Br} [N]	Specific spring rate C_{spez} [N]	Weight [kg/m]
25	6720	24500	1680000	0,18
32	8640	31500	2160000	0,23
50	14400	52500	3600000	0,37
75	21120	77000	5280000	0,54
100	28800	105000	7200000	0,74

Other widths are available on request.

Load / Elongation [%]

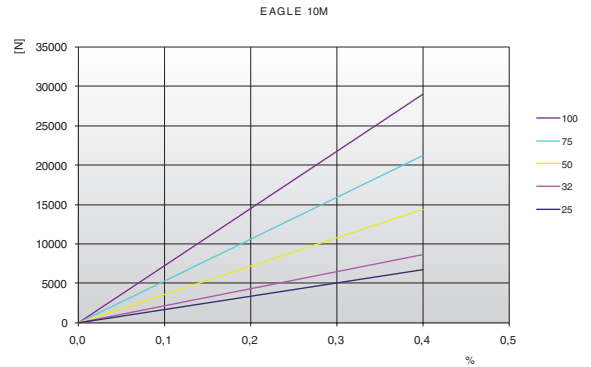

Tooth shear strength

rpm	F_{Uspez} [N/cm]	rpm	F_{Uspez} [N/cm]	rpm	F_{Uspez} [N/cm]	rpm	F_{Uspez} [N/cm]
0	93,50	800	64,43	1900	50,70	4500	35,37
20	92,03	900	62,70	2000	49,83	5000	33,42
40	90,63	1000	61,11	2200	48,19	5500	31,65
60	89,28	1100	59,63	2400	46,67	6000	30,02
80	88,00	1200	58,27	2600	45,27	6500	28,51
100	86,77	1300	56,99	2800	43,96	7000	27,12
200	81,36	1400	55,79	3000	42,73	7500	25,81
300	77,02	1440	55,33	3200	41,57	8000	24,59
400	73,54	1500	54,66	3400	40,48	8500	23,43
500	70,76	1600	53,59	3600	39,45	9000	22,34
600	68,43	1700	52,58	3800	38,46	9500	21,31
700	66,33	1800	51,62	4000	37,53	10000	20,33

Tooth shear strength / rpm

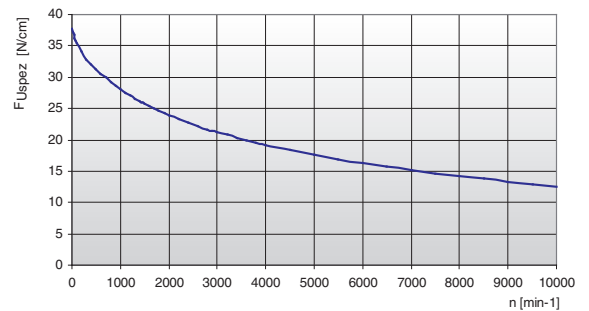

The specific load F_{Uspez} is the maximum load which one single belt tooth 1 cm wide can withstand in all operating conditions.

This force is related to the drive rpm.

The total load F_u transmissible by the belt in the drive is calculated by:

$$F_u [N] = F_{Uspez} \cdot Z_e \cdot b$$

- F_u [N] = peripheral force
- F_{Uspez} [N/cm] = specific load
- Z_e = number of teeth in mesh in the small pulley
- Z_{emax} = max. no of teeth in mesh to be considered for the calculation of the drive
- Z_{emax} = 12 for ELATECH® M
- Z_{emax} = 6 for ELATECH® V
- b [cm] = belt width in cm

EAGLE 10M

Flexibility

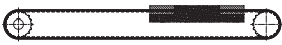
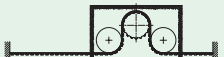
Minimum pulley number of teeth and minimum idler diameter		Type of cord
		STANDARD
Drive without reverse bending 	Timing pulley z_{min}	25
	Flat idler running on belt teeth d_{min}	80 mm
Drive with reverse bending 	Timing pulley z_{min}	25
	Flat idler running on belt back d_{min}	150 mm

Timing pulleys

z	da	dw	z	da	dw	z	da	dw	z	da	dw
18	55,29	57,29	48	150,78	152,78	78	246,24	248,24	108	341,76	343,76
19	58,48	60,48	49	153,97	155,97	79	249,46	251,46	109	344,95	346,95
20	61,66	63,66	50	157,15	159,15	80	252,64	254,64	110	348,13	350,13
21	64,84	66,84	51	160,33	162,33	81	255,82	257,82	111	351,31	353,31
22	68,03	70,03	52	163,52	165,52	82	259,00	261,00	112	354,50	356,50
23	71,20	73,20	53	166,70	168,70	83	262,19	264,19	113	357,68	359,68
24	74,39	76,39	54	169,88	171,88	84	265,37	267,37	114	360,86	362,86
25	77,58	79,58	55	173,06	175,06	85	268,52	270,52	115	364,04	366,04
26	80,76	82,76	56	176,25	178,25	86	271,74	273,74	116	367,23	369,23
27	83,95	85,95	57	179,43	181,43	87	274,92	276,92	117	370,41	372,41
28	87,12	89,12	58	182,61	184,61	88	278,10	280,10	118	373,59	375,59
29	90,21	92,21	59	185,80	187,80	89	281,28	283,28	119	376,78	378,78
30	93,49	95,49	60	188,98	190,98	90	284,47	286,47	120	379,96	381,96
31	96,67	98,67	61	192,16	194,16	91	287,65	289,65			
32	99,86	101,86	62	195,35	197,35	92	290,84	292,84			
33	103,04	105,04	63	198,53	200,53	93	294,02	296,02			
34	106,19	108,19	64	201,71	203,71	94	297,20	299,20			
35	109,41	111,41	65	204,90	206,90	95	300,39	302,39			
36	112,59	114,59	66	208,08	210,08	96	303,57	305,57			
37	115,77	117,77	67	211,26	213,26	97	306,75	308,75			
38	118,95	120,95	68	214,44	216,44	98	309,93	311,93			
39	122,14	124,14	69	217,63	219,63	99	313,12	315,12			
40	125,32	127,32	70	220,81	222,81	100	316,30	318,30			
41	128,50	130,50	71	223,99	225,99	101	319,48	321,48			
42	131,69	133,69	72	227,18	229,18	102	322,66	324,66			
43	134,87	136,87	73	230,33	232,33	103	325,85	327,85			
44	138,05	140,05	74	233,54	235,54	104	329,03	331,03			
45	141,24	143,24	75	236,72	238,72	105	332,21	334,21			
46	144,42	146,42	76	239,94	241,94	106	335,40	337,40			
47	147,60	149,60	77	243,09	245,09	107	338,58	340,58			

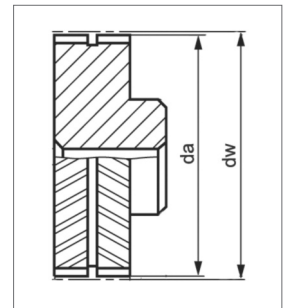

EAGLE 14M

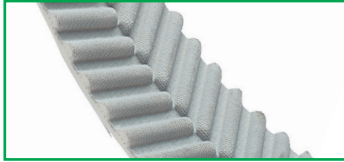
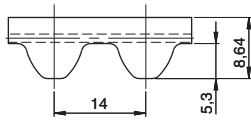

Belt characteristics

- Polyurethane timing belt with helical offset tooth, high tensile load steel cords and high torque capacity
- **Self tracking no need of pulley flanges**
- Metric pitch 14 mm
- **Extremely reduced noise generation**
- Offers excellent operational reliability in linear positioning, heavy power transmission and lifting applications
- The special profile allows most compact drive

- Width tolerance: $\pm 1,2$ [mm]
- Length tolerance: $\pm 0,8$ [mm/m]
- Thickness tolerance: $\pm 0,4$ [mm]

Technical Data

Belt width b [mm]	Allowable tensile load Type M F_{Tzul} [N]	Allowable tensile load Type V F_{Tzul} [N]	Breaking load Type M F_{Br} [N]	Specific spring rate C_{spez} [N]	Weight [kg/m]
35	11050	4650	41600	2762500	0,40
52,5	17000	7350	64000	4250000	0,60
70	22950	9800	86400	5737500	0,80
105	34850	16300	131200	8712500	1,20

Other widths are available on request.

Load / Elongation [%]

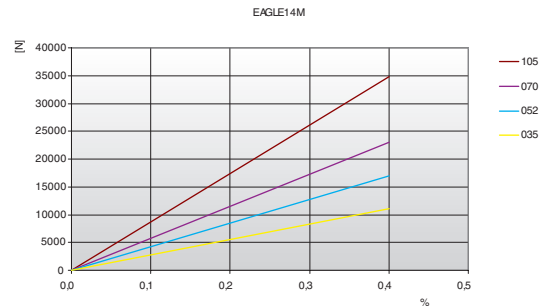

Tooth shear strength

rpm	F_{Uspez} [N/cm]	rpm	F_{Uspez} [N/cm]	rpm	F_{Uspez} [N/cm]	rpm	F_{Uspez} [N/cm]
0	160,00	800	103,35	1900	73,99	4000	46,21
20	157,00	900	99,60	2000	72,13	-	-
40	154,22	1000	96,17	2200	68,66	-	-
60	151,64	1100	93,01	2400	65,46	-	-
80	149,24	1200	90,08	2600	62,50	-	-
100	147,01	1300	87,35	2800	59,73	-	-
200	138,04	1400	84,80	2880	58,68	-	-
300	129,87	1440	83,82	3000	57,15	-	-
400	123,12	1500	82,39	3200	54,71	-	-
500	117,24	1600	80,12	3400	52,42	-	-
600	112,07	1700	77,97	3600	50,24	-	-
700	107,48	1800	75,93	3800	48,18	-	-

Tooth shear strength / rpm

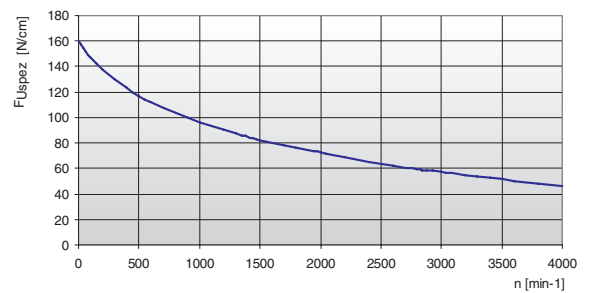

The specific load F_{Uspez} is the maximum load which one single belt tooth 1 cm wide can withstand in all operating conditions.

This force is related to the drive rpm.

The total load F_u transmissible by the belt in the drive is calculated by:

$$F_u [N] = F_{Uspez} \cdot Z_e \cdot b$$



- F_u [N] = peripheral force
- F_{Uspez} [N/cm] = specific load
- Z_e = number of teeth in mesh in the small pulley
- Z_{emax} = max. no of teeth in mesh to be considered for the calculation of the drive
- Z_{emax} = 12 for ELATECH® M
- Z_{emax} = 6 for ELATECH® V
- b [cm] = belt width in cm

EAGLE 14M

Specialties

Belt width b [mm]	HPL High Performance	
	F_{Tzul} [N] M type	F_{Br} [N]
35	12100	49500
52,5	17600	72000
70	24200	99000
105	37400	153000

Flexibility

Minimum pulley number of teeth and minimum idler diameter		Type of cord	
		STANDARD	HPL
Drive without reverse bending 	Timing pulley z_{min}	32	32
	Flat idler running on belt teeth d_{min}	140 mm	140 mm
Drive with reverse bending 	Timing pulley z_{min}	32	32
	Flat idler running on belt back d_{min}	200 mm	200 mm

Timing pulleys

z	da	dw	z	da	dw	z	da	dw	z	da	dw
28	122,12	124,77	58	255,68	258,46	88	389,37	392,15	119	527,51	530,30
29	126,58	129,22	59	260,14	262,91	89	393,83	396,60	120	531,97	534,75
30	130,99	133,69	60	264,60	267,38	90	398,29	401,07			
31	135,45	138,14	61	269,04	271,83	91	402,73	405,52			
32	139,88	142,59	62	273,50	276,28	92	407,19	409,97			
33	144,35	147,06	63	277,96	280,75	93	411,65	414,44			
34	148,79	151,51	64	282,42	285,20	94	416,10	418,89			
35	153,25	155,96	65	286,88	289,65	95	420,56	423,35			
36	157,68	160,41	66	291,32	294,11	96	425,02	427,80			
37	162,14	164,88	67	295,78	298,56	97	429,48	432,25			
38	166,60	169,34	68	300,24	303,03	98	433,94	436,72			
39	171,02	173,79	69	304,70	307,48	99	438,38	441,17			
40	175,48	178,24	70	309,16	311,93	100	442,84	445,62			
41	179,92	182,71	71	313,61	316,40	101	447,30	450,09			
42	184,37	187,16	72	318,07	320,85	102	451,76	454,54			
43	188,83	191,61	73	322,53	325,30	103	456,21	459,00			
44	193,29	196,08	74	326,98	329,77	104	460,67	463,45			
45	197,75	200,53	75	331,44	334,22	105	465,13	467,90			
46	202,21	204,98	76	335,90	338,67	106	469,58	472,37			
47	206,65	209,43	77	340,34	343,12	107	474,03	476,82			
48	211,11	213,90	78	344,80	347,59	108	478,49	481,28			
49	215,57	218,35	79	349,26	352,04	109	482,95	485,74			
50	220,03	222,80	80	353,72	356,49	110	487,41	490,19			
51	224,49	227,27	81	358,17	360,96	111	491,87	494,64			
52	228,95	231,72	82	362,63	365,41	112	496,32	499,10			
53	233,39	236,18	83	367,09	369,86	113	500,78	503,55			
54	237,85	240,64	84	371,54	374,33	114	505,23	508,02			
55	242,30	245,09	85	376,00	378,78	116	514,14	516,93			
56	246,76	249,55	86	380,46	383,23	117	518,60	521,38			
57	251,22	254,01	87	384,91	387,70	118	523,06	525,83			

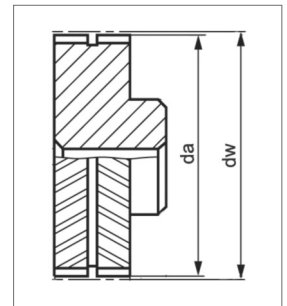

EAGLE 14M XHPL

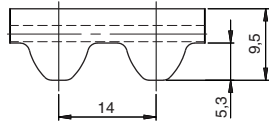

Belt characteristics

- Polyurethane timing belt with helical offset tooth, high tensile load steel cords and high torque capacity.
- **Self tracking no need of pulley flanges**
- Metric pitch 14 mm
- **Extremely reduced noise generation**
- **E14M - XHPL is the ideal belt for heavy duty synchronous lifting applications.**
- The special profile allows most compact drive
- **White colour and grey fabric backing on tooth size (PAZ) as standard.**

- Width tolerance: $\pm 1,2$ [mm]
- Length tolerance: $\pm 1,0$ [mm/m]
- Thickness tolerance: $\pm 0,5$ [mm]

Technical Data

Belt width b [mm]	Allowable tensile load Type M F_{Tzul} [N]	Breaking load Type M F_{Br} [N]	Specific spring rate C_{spez} [N]	Weight [kg/m]
35	16000	56000	4000000	0,50
52,5	28000	98000	7000000	0,70

Other widths are available on request.

Load / Elongation [%]

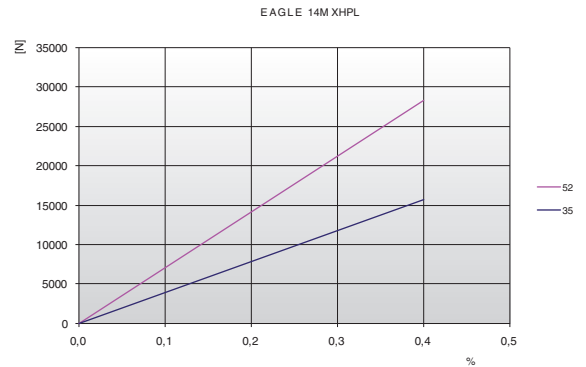

Tooth shear strength

rpm	F_{Uspez} [N/cm]	rpm	F_{Uspez} [N/cm]	rpm	F_{Uspez} [N/cm]	rpm	F_{Uspez} [N/cm]
0	160,00	800	103,35	1900	73,99	4000	46,21
20	157,00	900	99,60	2000	72,13	-	-
40	154,22	1000	96,17	2200	68,66	-	-
60	151,64	1100	93,01	2400	65,46	-	-
80	149,24	1200	90,08	2600	62,50	-	-
100	147,01	1300	87,35	2800	59,73	-	-
200	138,04	1400	84,80	2880	58,68	-	-
300	129,87	1440	83,82	3000	57,15	-	-
400	123,12	1500	82,39	3200	54,71	-	-
500	117,24	1600	80,12	3400	52,42	-	-
600	112,07	1700	77,97	3600	50,24	-	-
700	107,48	1800	75,93	3800	48,18	-	-

Tooth shear strength / rpm

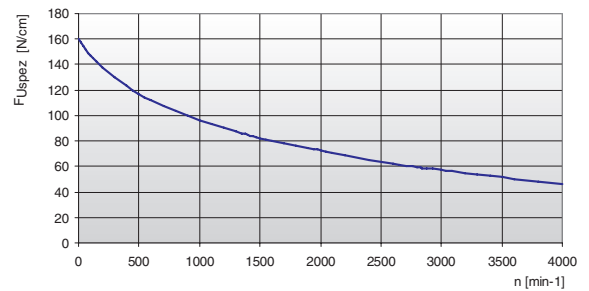

The specific load F_{Uspez} is the maximum load which one single belt tooth 1 cm wide can withstand in all operating conditions.

This force is related to the drive rpm.

The total load F_u transmissible by the belt in the drive is calculated by:

$$F_u [N] = F_{Uspez} \cdot Z_e \cdot b$$

- F_u [N] = peripheral force
- F_{Uspez} [N/cm] = specific load
- Z_e = number of teeth in mesh in the small pulley
- Z_{emax} = max. no of teeth in mesh to be considered for the calculation of the drive
- Z_{emax} = 12 for ELATECH® M
- Z_{emax} = 6 for ELATECH® V
- b [cm] = belt width in cm

EAGLE 14M XHPL

Flexibility

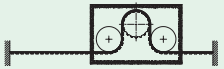
Minimum pulley number of teeth and minimum idler diameter		Type of cord
		STANDARD
Drive without reverse bending 	Timing pulley z_{min}	34
	Flat idler running on belt teeth d_{min}	140 mm
Drive with reverse bending 	Timing pulley z_{min}	34
	Flat idler running on belt back d_{min}	200 mm

Timing pulleys

Nota

Pulleys with special EAGLE 14M - XHPL profile on request.
Contact our technical department.

TK 5 K6

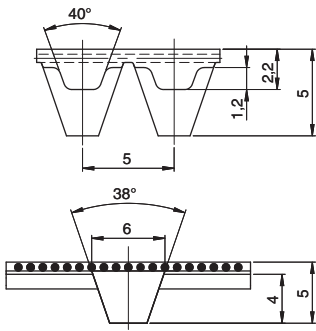

Belt characteristics

- Polyurethane self tracking timing belt with steel tension cords
- Profile T5 with central guide - K6 x 4 mm
- Central guide height 4,0 mm
- Allow to use pulleys without flanges
- The central guide is notched in order to maximize belt flexibility
- Ideal for conveying applications where a side load is generated by loading/unloading transferring a product

- Width tolerance: $\pm 0,5$ [mm]
- Length tolerance: $\pm 0,5$ [mm/m]

Technical Data

Belt width b [mm]	Allowable tensile load Type M F_{Tzul} [N]	Allowable tensile load Type V F_{Tzul} [N]	Breaking load Type M F_{Br} [N]	Specific spring rate C_{spez} [N]	Weight [kg/m]
32	1150	575	4500	287500	0,080
50	1860	930	7250	465000	0,130
75	2820	1410	11000	705000	0,200
100	3780	1890	14750	945000	0,260

Load / Elongation [%]

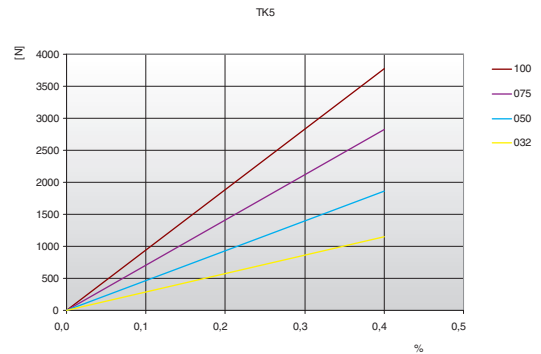

Specialties

Belt width b [mm]	ARAMID CORD	
	F_{Tzul} [N] M type	F_{Br} [N]
32	2520	10080
50	4060	16240
75	6160	24640
100	8260	33040

Pulley profile

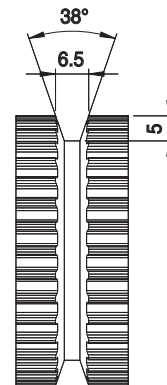

Flexibility

Minimum pulley number of teeth and minimum idler diameter		Type of cord
		STANDARD
Drive without reverse bending 	Timing pulley Z_{min}	14
	Flat idler running on belt teeth d_{min}	40 mm
Drive with reverse bending 	Timing pulley Z_{min}	15
	Flat idler running on belt back d_{min}	40 mm

TK 10 K13 - K6

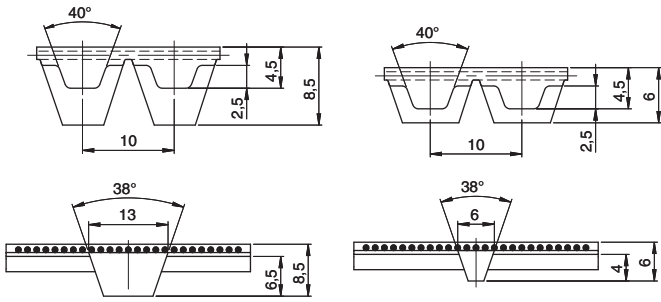

K13

K6

Belt characteristics

- Polyurethane self track timing belt with steel tension cords
- Profile T10 with central guide - K13 x 6,5
- Profile T10 with central guide - K6 x 4,0
- Central guide height 6,5 mm
- Allow to use pulleys without flanges
- The central guide is notched in order to maximize belt flexibility
- Ideal for conveying applications where a side load is generated by loading/unloading transferring a product

- Width tolerance: $\pm 0,5$ [mm]
- Length tolerance: $\pm 0,5$ [mm/m]

Technical Data

Belt width b [mm]	Allowable tensile load Type M F_{Tzul} [N]	Allowable tensile load Type V F_{Tzul} [N]	Breaking load Type M F_{Br} [N]	Specific spring rate C_{spez} [N]	Weight [kg/m]
32	3450	1725	12600	862500	0,220
50	5520	2760	20160	1380000	0,300
75	8400	4200	30660	2100000	0,410
100	11270	5635	41160	2817500	0,530
150	17020	8510	62160	4255000	0,850

150 mm width available only in K6 execution.

Load / Elongation [%]

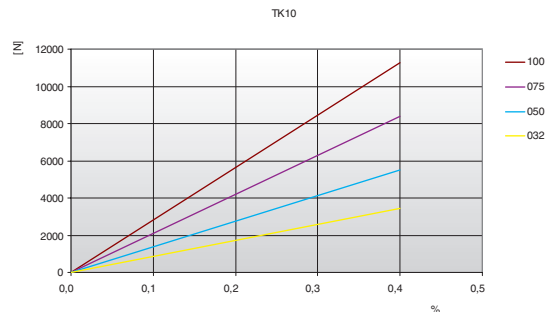

Specialties

Belt width b [mm]	ARAMID CORD	
	F_{Tzul} [N] M type	F_{Br} [N]
32	3300	13500
50	8280	21600
75	8030	32850
100	10780	44100
150	16280	66600

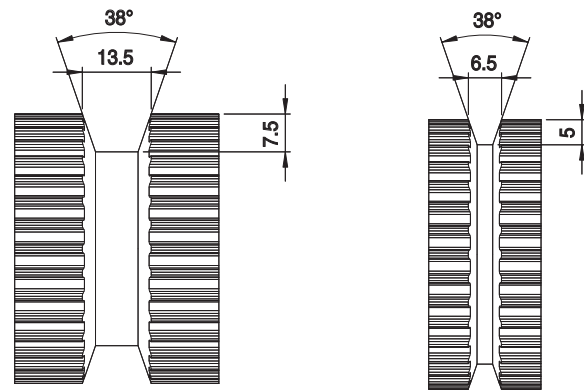

Pulley profile



K13

K6

Flexibility

Minimum pulley number of teeth and minimum idler diameter		Guide	
		K6	K13
 Drive without reverse bending	Timing pulley Z_{min}	14	16
	Flat idler running on belt teeth d_{min}	60 mm	80 mm
 Drive with reverse bending	Timing pulley Z_{min}	20	20
	Flat idler running on belt back d_{min}	60 mm	60 mm

ATK 5 K6

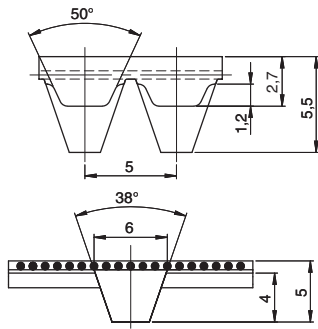

Belt characteristics

- Polyurethane self track timing belt with steel tension cords
- Profile AT5 with central guide - K6 x 4 mm
- Central guide height 4,0 mm
- Allow to use pulleys without flanges
- The central guide is notched in order to maximize belt flexibility
- Ideal for conveying applications where a side load is generated by loading/unloading transferring a product

- Width tolerance: $\pm 0,5$ [mm]
- Length tolerance: $\pm 0,5$ [mm/m]

Technical Data

Belt width b [mm]	Allowable tensile load Type M F_{Tzul} [N]	Allowable tensile load Type V F_{Tzul} [N]	Breaking load Type M F_{Br} [N]	Specific spring rate C_{spez} [N]	Weight [kg/m]
32	3450	1725	12600	862500	0,11
50	5520	2760	20160	1380000	0,19
75	8400	4200	30660	2100000	0,29
100	11270	5635	41160	2817500	0,38

Load / Elongation [%]

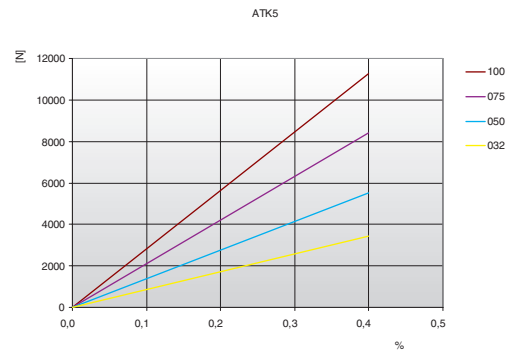

Specialties

Belt width b [mm]	ARAMID CORD	
	F_{Tzul} [N] M type	F_{Br} [N]
32	3300	13500
50	8280	21600
75	8030	32850
100	10780	44100

Pulley profile

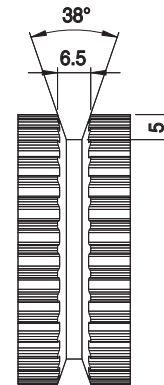

Flexibility

Minimum pulley number of teeth and minimum idler diameter		Type of cord
		STANDARD
Drive without reverse bending 	Timing pulley Z_{min}	25
	Flat idler running on belt teeth d_{min}	60 mm
Drive with reverse bending 	Timing pulley Z_{min}	25
	Flat idler running on belt back d_{min}	80 mm

ATK 10 K13 - K6

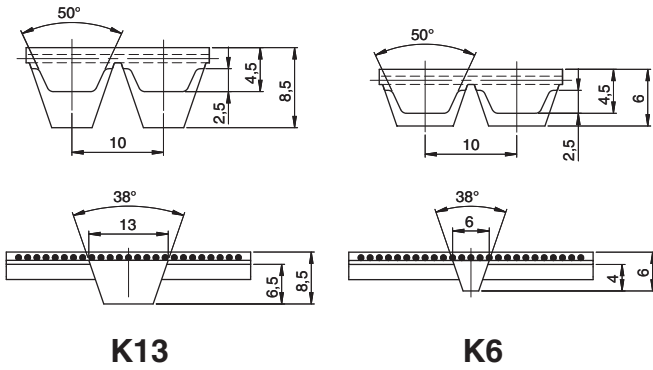

Belt characteristics

- Polyurethane self track timing belt with steel tension cords
- Profile AT10 with central guide - K13 x 6,5 mm
- Profile AT10 with central guide - K6 x 4 mm
- Central guide height 6,5 mm
- Allow to use pulleys without flanges
- The central guide is notched in order to maximize belt flexibility
- Ideal for conveying applications where a side load is generated by loading/unloading transferring a product

- Width tolerance: $\pm 0,5$ [mm]
- Length tolerance: $\pm 0,5$ [mm/m]

Technical Data

Belt width b [mm]	Allowable tensile load Type M F_{Tzul} [N]	Allowable tensile load Type V F_{Tzul} [N]	Breaking load Type M F_{Br} [N]	Specific spring rate C_{spez} [N]	Weight [kg/m]
32	5390	2695	20900	1347500	0,27
50	8580	4290	33250	2145000	0,36
75	12990	6495	50350	3247500	0,50
100	17400	8700	67450	4350000	0,72
150	25970	13110	100700	6492500	1,08

150 mm width available only in K13 execution.

Load / Elongation [%]

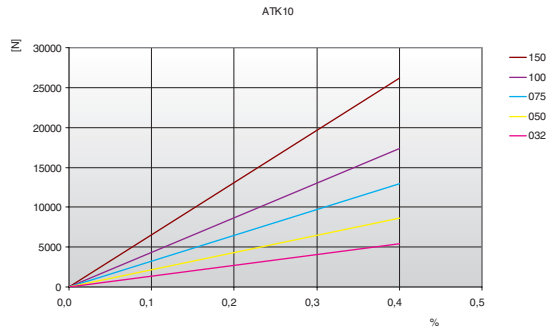

Specialties

Belt width b [mm]	ARAMID CORD	
	F_{Tzul} [N] M type	F_{Br} [N]
32	4180	17380
50	6650	27650
75	10070	41870
100	13490	56090
150	20330	84530

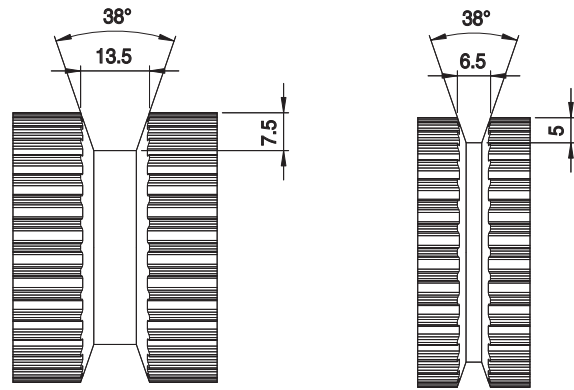

Pulley profile



K13

K6

Flexibility

Minimum pulley number of teeth and minimum idler diameter		Guide	
		K6	K13
 Drive without reverse bending	Timing pulley z_{min}	15	17
	Flat idler running on belt teeth d_{min}	50 mm	50 mm
 Drive with reverse bending	Timing pulley z_{min}	25	25
	Flat idler running on belt back d_{min}	120 mm	120 mm

T 10 TOTAL PROTECTION

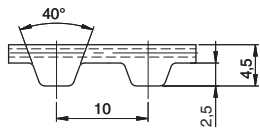

Belt characteristics

- Polyurethane timing belt with steel tension cords
- Tooth profile according to ISO 17396
- Metric pitch 10 mm
- **TP (Total Protection) belt. The absence of tooth gap makes the belt cords protected against corrosion**
- **Widely used in applications with corrosive environment, high humidity**
- Light blue color available on request

- Width tolerance: ±0,5 [mm]
- Length tolerance: ±0,5 [mm/m]
- Thickness tolerance: ±0,2 [mm]

Technical Data

Belt width b [mm]	Allowable tensile load Type M F _{Tzul} [N]	Allowable tensile load Type V F _{Tzul} [N]	Breaking load Type M F _{Br} [N]	Specific spring rate C _{spez} [N]	Weight [kg/m]
10	920	460	3360	230000	0,05
16	1610	805	5880	402500	0,07
25	2650	1325	9660	662500	0,11
32	3450	1725	12600	862500	0,15
50	5520	2760	20160	1380000	0,23
75	8400	4200	30660	2100000	0,34
100	11270	5635	41160	2817500	0,45

Other widths are available on request.

Load / Elongation [%]

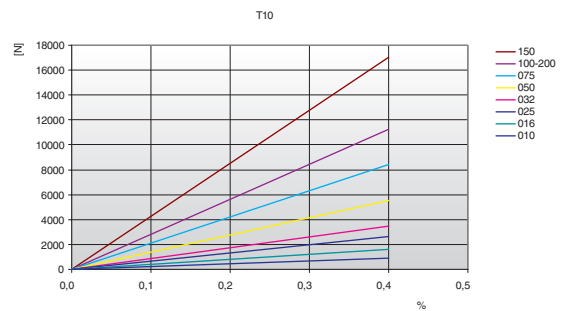

Tooth shear strength

rpm	F _{Uspez} [N/cm]	rpm	F _{Uspez} [N/cm]	rpm	F _{Uspez} [N/cm]	rpm	F _{Uspez} [N/cm]
0	51,80	800	33,34	1900	26,53	4500	19,40
20	50,32	900	32,44	2000	26,12	5000	18,51
40	49,04	1000	31,63	2200	25,34	5500	17,70
60	47,92	1100	30,89	2400	24,63	6000	16,97
80	46,95	1200	30,21	2600	23,97	6500	16,29
100	46,11	1300	29,58	2800	23,36	7000	15,66
200	42,75	1400	28,99	3000	22,78	7500	15,07
300	40,28	1440	28,76	3200	22,25	8000	14,52
400	38,36	1500	28,44	3400	21,74	8500	14,00
500	36,80	1600	27,92	3600	21,27	9000	13,51
600	35,49	1700	27,43	3800	20,81	9500	13,05
700	34,35	1800	26,97	4000	20,39	10000	12,61

Tooth shear strength / rpm

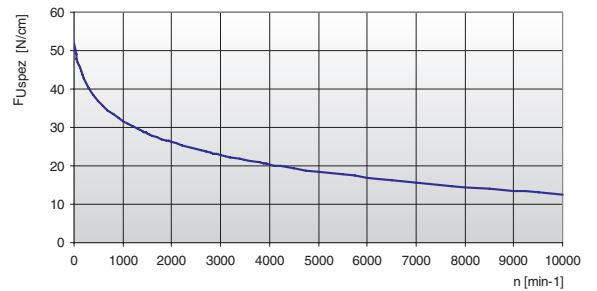

The specific load F_{Uspez} is the maximum load which one single belt tooth 1 cm wide can withstand in all operating conditions. This force is related to the drive rpm. The total load F_u transmissible by the belt in the drive is calculated by:

$$F_u [N] = F_{Uspez} \cdot Z_e \cdot b$$

- F_u [N] = peripheral force
- F_{Uspez} [N/cm] = specific load
- Z_e = number of teeth in mesh in the small pulley
- Z_{e,max} = max. no of teeth in mesh to be considered for the calculation of the drive
- Z_{e,max} = 12 for ELATECH® M
- Z_{e,max} = 6 for ELATECH® V
- b [cm] = belt width in cm

T 10 TOTAL PROTECTION

Flexibility

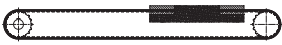
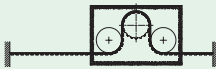
Minimum pulley number of teeth and minimum idler diameter		Type of cord
		STANDARD
Drive without reverse bending 	Timing pulley z_{min}	12
	Flat idler running on belt teeth d_{min}	60 mm
Drive with reverse bending 	Timing pulley z_{min}	20
	Flat idler running on belt back d_{min}	60 mm

Timing pulleys

z	da	dw	z	da	dw	z	da	dw	z	da	dw
10	30,05	31,84	40	125,45	127,32	71	224,15	225,99	101	319,65	321,48
11	33,25	35,02	41	128,65	130,50	72	227,30	229,18	102	322,80	324,66
12	36,35	38,20	42	131,85	133,69	73	230,50	232,36	103	326,00	327,85
13	39,50	41,38	44	138,20	140,05	74	233,70	235,54	104	329,20	331,03
14	42,70	44,56	45	141,40	143,24	75	236,90	238,72	105	332,35	334,21
15	45,90	47,75	46	144,60	146,42	76	240,05	241,94	106	335,55	337,40
16	49,05	50,93	47	147,75	149,60	77	243,25	245,09	107	338,75	340,58
17	52,25	54,11	48	150,95	152,78	78	246,40	248,27	108	341,95	343,76
18	55,45	57,29	49	154,10	155,97	79	249,60	251,46	109	345,15	346,95
19	58,65	60,48	50	157,30	159,15	80	252,80	254,64	110	348,30	350,13
20	61,80	63,66	51	160,50	162,33	81	256,00	257,82	111	351,45	353,31
21	65,00	66,84	52	163,65	165,52	82	259,15	261,00	112	354,65	356,50
22	68,15	70,03	53	166,85	168,70	83	262,30	264,19	113	357,80	359,68
23	71,35	73,20	54	170,05	171,88	84	265,50	267,37	114	361,00	362,86
24	74,55	76,39	55	173,20	175,06	85	268,70	270,55	115	364,19	366,04
25	77,70	79,58	56	176,40	178,25	86	271,90	273,74	116	367,39	369,23
26	80,90	82,76	57	179,60	181,43	87	275,05	276,92	117	370,56	372,41
27	84,10	85,95	58	182,75	184,61	88	278,25	280,10	118	373,76	375,59
28	87,25	89,12	59	185,95	187,80	89	281,45	283,28	119	376,93	378,78
29	90,45	92,21	60	189,10	190,98	90	284,60	286,47	120	380,11	381,96
30	93,65	95,49	61	192,30	194,16	91	287,80	289,65			
31	96,85	98,67	62	195,50	197,35	92	291,00	292,84			
32	100,00	101,86	63	198,65	200,53	93	294,20	296,02			
33	103,20	105,04	64	201,85	203,71	94	297,35	299,20			
34	106,40	108,22	65	205,05	206,90	95	300,55	302,39			
35	109,55	111,41	66	208,20	210,08	96	303,75	305,57			
36	112,75	114,59	67	211,40	213,26	97	306,90	308,75			
37	115,90	117,77	68	214,60	216,44	98	310,10	311,93			
38	119,10	120,95	69	217,75	219,63	99	313,25	315,12			
39	122,30	124,14	70	220,95	222,81	100	316,45	318,30			

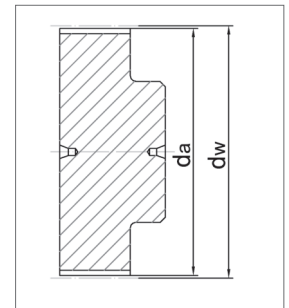

AT 10 TOTAL PROTECTION

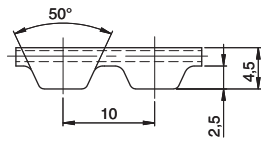

Belt characteristics

- Polyurethane timing belt with steel tension cords
- Metric pitch 10 mm
- Tooth profile according to ISO 17396
- Tooth profile and dimension are optimised to guarantee uniform load distribution and minimum deformation under load
- High resistance and low stretch steel cords to guarantee high stability and low elongation
- Reduced polygonal effect with reduced drive vibration
- **TP (Total Protection) belt. The absence of tooth gap makes the belt cords protected against corrosion**
- **Widely used in applications with corrosive environment, high humidity**
- Light blue color available on request

- Width tolerance: $\pm 0,5$ [mm]
- Length tolerance: $\pm 0,8$ [mm/m]
- Thickness tolerance: $\pm 0,2$ [mm]

Technical Data

Belt width b [mm]	Allowable tensile load Type M F _{Tzul} [N]	Allowable tensile load Type V F _{Tzul} [N]	Breaking load Type M F _{Br} [N]	Specific spring rate C _{spez} [N]	Weight [kg/m]
16	2450	1225	9500	612500	0,09
25	4170	2085	16150	1042500	0,15
32	5390	2695	20900	1347500	0,19
50	8580	4290	33250	2145000	0,30
75	12990	6495	50350	3247500	0,44
100	17400	8700	67450	4350000	0,59

Other widths are available on request.

Load / Elongation [%]

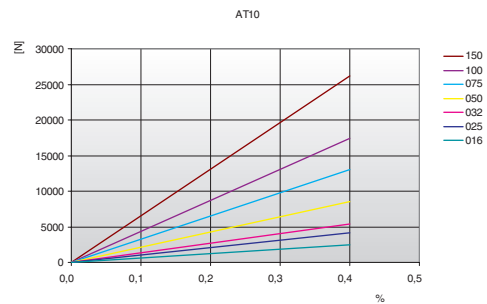

Tooth shear strength

rpm	F _{Uspez} [N/cm]	rpm	F _{Uspez} [N/cm]	rpm	F _{Uspez} [N/cm]	rpm	F _{Uspez} [N/cm]
0	88,57	800	62,83	1900	49,16	4500	34,08
20	87,06	900	61,09	2000	48,29	5000	32,17
40	85,66	1000	59,49	2200	46,67	5500	30,43
60	84,35	1100	58,02	2400	45,18	6000	28,84
80	83,13	1200	56,66	2600	43,80	6500	27,37
100	81,99	1300	55,39	2800	42,51	7000	26,01
200	77,36	1400	54,20	3000	41,30	7500	24,73
300	75,09	1440	53,74	3200	40,17	8000	23,53
400	71,99	1500	53,08	3400	39,09	8500	22,41
500	69,27	1600	52,02	3600	38,08	9000	21,34
600	66,88	1700	51,02	3800	37,11	9500	20,33
700	64,75	1800	50,06	4000	36,20	10000	19,37

Tooth shear strength / rpm

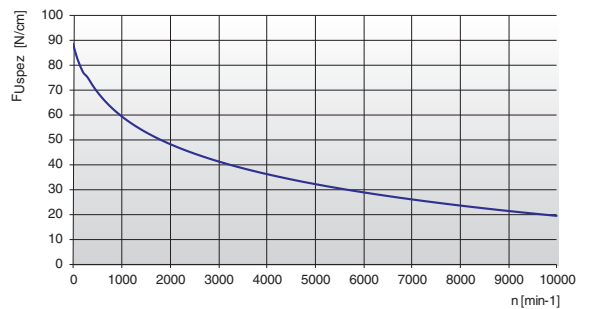

The specific load F_{Uspez} is the maximum load which one single belt tooth 1 cm wide can withstand in all operating conditions.

This force is related to the drive rpm.



The total load F_u transmissible by the belt in the drive is calculated by:

$$F_u [N] = F_{Uspez} \cdot Z_e \cdot b$$

- F_u [N] = peripheral force
- F_{Uspez} [N/cm] = specific load
- Z_e = number of teeth in mesh in the small pulley
- Z_{e,max} = max. no of teeth in mesh to be considered for the calculation of the drive
- Z_{e,max} = 12 for ELATECH® M
- Z_{e,max} = 6 for ELATECH® V
- b [cm] = belt width in cm

AT 10 TOTAL PROTECTION

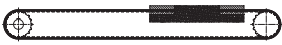
Flexibility

Minimum pulley number of teeth and minimum idler diameter		Type of cord
		STANDARD
Drive without reverse bending 	Timing pulley z_{min}	15
	Flat idler running on belt teeth d_{min}	50 mm
Drive with reverse bending 	Timing pulley z_{min}	25
	Flat idler running on belt back d_{min}	120 mm

Timing pulleys

z	da	dw	z	da	dw	z	da	dw	z	da	dw
18	55,45	57,29	48	150,95	152,78	78	246,40	248,24	108	341,90	343,76
19	58,60	60,48	49	154,10	155,97	79	249,60	251,46	109	345,10	346,95
20	61,80	63,66	50	157,30	159,15	80	252,80	254,64	110	348,30	350,13
21	65,00	66,84	51	160,50	162,33	81	255,95	257,82	111	351,45	353,31
22	68,15	70,03	52	163,65	165,52	82	259,15	261,00	112	354,65	356,50
23	71,35	73,20	53	166,85	168,70	83	262,30	264,19	113	357,80	359,68
24	74,55	76,39	54	170,05	171,88	84	265,50	267,37	114	361,00	362,86
25	77,70	79,58	55	173,20	175,06	85	268,70	270,52	115	364,19	366,04
26	80,90	82,76	56	176,40	178,25	86	271,90	273,74	116	367,39	369,23
27	84,10	85,95	57	179,60	181,43	87	275,05	276,92	117	370,56	372,41
28	87,25	89,12	58	182,75	184,61	88	278,25	280,10	118	373,74	375,59
29	90,45	92,21	59	185,95	187,80	89	281,45	283,28	119	376,93	378,78
30	93,65	95,49	60	189,10	190,98	90	284,60	286,47	120	380,11	381,96
31	96,80	98,67	61	192,30	194,16	91	287,80	289,65			
32	100,00	101,86	62	195,50	197,35	92	291,00	292,84			
33	103,20	105,04	63	198,65	200,53	93	294,20	296,02			
34	106,40	108,19	64	201,85	203,71	94	297,35	299,20			
35	109,55	111,41	65	205,05	206,90	95	300,55	302,39			
36	112,75	114,59	66	208,20	210,08	96	303,70	305,57			
37	115,90	117,77	67	211,40	213,26	97	306,90	308,75			
38	119,10	120,95	68	214,60	216,44	98	310,10	311,93			
39	122,30	124,14	69	217,75	219,63	99	313,25	315,12			
40	125,45	127,32	70	220,95	222,81	100	316,45	318,30			
41	128,65	130,50	71	224,15	225,99	101	319,65	321,48			
42	131,85	133,69	72	227,30	229,18	102	322,80	324,66			
43	135,00	136,87	73	230,50	232,33	103	326,00	327,85			
44	138,20	140,05	74	233,70	235,54	104	329,20	331,03			
45	141,40	143,24	75	236,90	238,72	105	332,35	334,21			
46	144,55	146,42	76	240,05	241,94	106	335,55	337,40			
47	147,75	149,60	77	243,25	245,09	107	338,75	340,58			

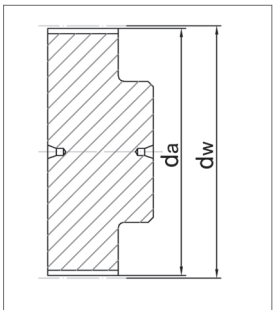

HTD 8M TOTAL PROTECTION

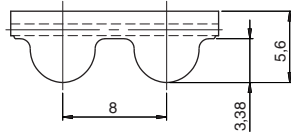

Belt characteristics

- Polyurethane timing belt with round tooth profile and high tensile load tension cords.
- Tooth profile according to ISO 13050
- Metric pitch 8 mm
- The round tooth profile allows a uniform load distribution that guarantees high performances, high transmissible torque and precise tooth engagement
- **TP (Total Protection) belt. The absence of tooth gap makes the belt protected against corrosion**
- **Widely used in applications with corrosive environment**
- Light blue color available on request

- Width tolerance: $\pm 0,5$ [mm]
- Length tolerance: $\pm 0,5$ [mm/m]
- Thickness tolerance: $\pm 0,2$ [mm]

Technical Data

Belt width b [mm]	Allowable tensile load Type M F_{Tzul} [N]	Allowable tensile load Type V F_{Tzul} [N]	Breaking load Type M F_{Br} [N]	Specific spring rate C_{spez} [N]	Weight [kg/m]
10	1470	735	5700	367500	0,07
15	2210	1105	8550	552500	0,11
20	3190	1595	12350	797500	0,14
30	4900	2450	19000	1225000	0,21
50	8580	4290	33250	2145000	0,35
85	14700	7350	57000	3675000	0,60
100	17400	8700	67450	4350000	0,70

Other widths are available on request.

Load / Elongation [%]

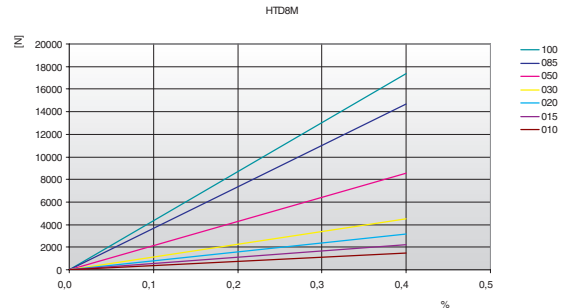

Tooth shear strength

rpm	F_{Uspez} [N/cm]	rpm	F_{Uspez} [N/cm]	rpm	F_{Uspez} [N/cm]	rpm	F_{Uspez} [N/cm]
0	74,00	800	51,20	1900	39,52	4500	26,63
20	72,62	900	49,71	2000	38,78	5000	25,00
40	71,34	1000	48,35	2200	37,39	5500	23,51
60	70,16	1100	47,09	2400	36,12	6000	22,15
80	69,07	1200	45,93	2600	34,94	-	-
100	68,07	1300	44,84	2800	33,83	-	-
200	64,09	1400	43,82	3000	32,80	-	-
300	61,68	1440	43,43	3200	31,83	-	-
400	59,03	1500	42,86	3400	30,91	-	-
500	56,71	1600	41,96	3600	30,05	-	-
600	54,66	1700	41,10	3800	29,22	-	-
700	52,84	1800	40,29	4000	28,44	-	-

Tooth shear strength / rpm

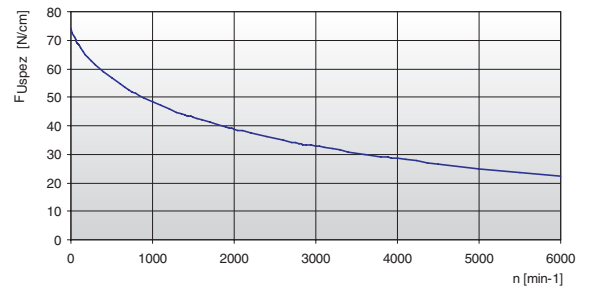

The specific load F_{Uspez} is the maximum load which one single belt tooth 1 cm wide can withstand in all operating conditions. This force is related to the drive rpm.

The total load F_u transmissible by the belt in the drive is calculated by:

$$F_u [N] = F_{Uspez} \cdot Z_e \cdot b$$

- F_u [N] = peripheral force
- F_{Uspez} [N/cm] = specific load
- Z_e = number of teeth in mesh in the small pulley
- Z_{emax} = max. no of teeth in mesh to be considered for the calculation of the drive
- Z_{emax} = 12 for ELATECH® M
- Z_{emax} = 6 for ELATECH® V
- b [cm] = belt width in cm

HTD 8M TOTAL PROTECTION

Flexibility

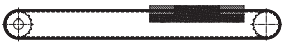
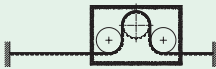
Minimum pulley number of teeth and minimum idler diameter		Type of cord
		STANDARD
Drive without reverse bending 	Timing pulley z_{min}	18
	Flat idler running on belt teeth d_{min}	50 mm
Drive with reverse bending 	Timing pulley z_{min}	18
	Flat idler running on belt back d_{min}	120 mm

Timing pulleys

z	da	dw	z	da	dw	z	da	dw	z	da	dw
18	44,46	45,83	48	120,86	122,23	78	197,25	198,62	108	273,64	275,01
19	47,01	48,38	49	123,40	124,77	79	199,80	201,17	109	276,19	277,56
20	49,56	50,93	50	125,95	127,32	80	202,35	203,72	110	278,74	280,11
21	52,10	53,47	51	128,50	129,87	81	204,89	206,26	111	281,29	282,66
22	54,65	56,02	52	131,05	132,41	82	207,44	208,81	112	283,84	285,21
23	57,20	58,57	53	133,59	134,96	83	209,98	211,35	113	286,38	287,75
24	59,75	61,12	54	136,14	137,51	84	212,53	213,90	114	288,93	290,30
25	62,29	63,66	55	138,68	140,05	85	215,08	216,45	115	291,47	292,84
26	64,84	66,21	56	141,23	142,60	86	217,63	219,00	116	294,02	295,39
27	67,38	68,75	57	143,78	145,15	87	220,17	221,54	117	296,57	297,94
28	70,08	71,30	58	146,32	147,69	88	222,72	224,09	118	299,11	300,48
29	72,59	73,84	59	148,87	150,24	89	225,26	226,63	119	301,66	303,03
30	75,13	76,39	60	151,42	152,79	90	227,81	229,18	120	304,20	305,57
31	77,65	78,94	61	153,96	155,33	91	230,35	231,72			
32	80,16	81,49	62	156,52	157,89	92	232,90	234,27			
33	82,68	84,03	63	159,06	160,43	93	235,45	236,82			
34	85,21	86,58	64	161,60	162,97	94	238,00	239,37			
35	87,76	89,12	65	164,15	165,52	95	240,54	241,91			
36	90,30	91,67	66	166,69	168,06	96	243,09	244,46			
37	92,85	94,22	67	169,24	170,61	97	245,63	247,00			
38	95,40	96,77	68	171,79	173,16	98	248,18	249,55			
39	97,94	99,31	69	174,33	175,70	99	250,73	252,10			
40	100,49	101,86	70	176,88	178,25	100	253,28	254,67			
41	103,04	104,40	71	179,43	180,80	101	255,82	257,19			
42	105,58	106,95	72	181,98	183,35	102	258,37	259,74			
43	108,13	109,50	73	184,52	185,89	103	260,91	262,28			
44	110,68	112,05	74	187,07	188,44	104	263,46	264,83			
45	113,22	114,59	75	189,61	190,98	105	266,01	267,38			
46	115,77	117,14	76	192,16	193,53	106	268,55	269,92			
47	118,31	119,68	77	194,71	196,08	107	271,10	272,47			

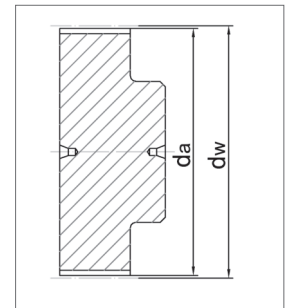

ELATECH® flat belts

ELATECH® flat belt's superior construction makes them the best solution in a wide range of lifting applications. Compared to steel cable they offer proven reliability, highly compact drives, maintenance-free operation and excellent dynamic properties.

Compact size and maintenance-free operation allow:

- low inertia, space savings and therefore lower manufacturing cost solutions
- lower power consumption in operation and therefore reduced running costs

In order to optimize the application in load and flexibility, ELATECH® flat belts are produced in a range of different thicknesses and steel cord diameters.

Pulleys

In some cases it is also possible to use guiding pulleys with a convex barrel shape. In this case we recommend following the specifications of the ISO R22 - DIN 111 norms. The use of the convex barrel pulleys, will result in an uneven force distribution in the belt. Therefore the allowable forces in the belt need to be revised.

Belt storage

Belts must be stored in a dry environment (max 60% relative humidity) with a temperature from 5 to 35 °C.

Belt installation

For a correct belt installation it is important that the belt's ends are securely and firmly fastened by the use of the correct belt end attachments. It is also recommended to use a very rigid and accurate assembly with perfectly parallel and rigid shafts. Belts and pulleys must be free from oil and grease and any dust or residual material which may affect the belt integrity during operation.

Belt fastening guidelines

Belt type [mm]	F1	F2	F2,5	F3
a	25	45	50	75
b	40	60	80	125
p	20	20	20	25
s	3	5	5	5
d	15	30	30	50
Bolt	M5	M6	M8	M8
R (Radius)	12	12	12	20

Pulley [mm]	F1	F2	F2,5	F3
D	50	60	80	120

It's recommended to have at least 2 turns on pulley.

Pulley diameter depends on the type of belt and on the design load required by the application. Our catalogue suggests minimum diameters for use with the maximum allowable load. For an accurate pulley diameter calculation under different load conditions please contact our technical department. The recommended pulley geometry is cylindrical with side flanges.

Proper design of belt ends is recommended to ensure application safety. Some possible design solutions for belt end clamping are shown here as examples.

ELATECH® flat belts are produced with a polyurethane body ensuring very high wear resistance. Steel tension cords of opposite construction (Z and S) are laid out in pairs to maximize dynamic properties. They provide excellent operational performance with low noise and vibrations and long lifetime.

In applications with more belts acting in parallel it is suggested to use belts from the same manufacturing batch with minimum belt thickness tolerance. The belt drive must be started up only when the entire machine or assembly has the necessary protective systems which meet the machine's safety guidelines. Belts are maintenance free, however, an accurate visual inspection of the belts and end attachments must be taken at least once per year.

TP (Total Protection) Belts

TP flat belts (without tooth gap) are available on demand. Ask our technical Department for product specifications.

Belt life

Due to the wide application range and considering the fact that belts are one component of complex equipment, the loads in the belt itself are very seldom precisely predictable. This fact makes it impossible to confirm a precise belt service life. In order to optimize the belt life, it is important to follow the catalogue technical specifications related to pulley geometry and belt storage and installation. When all the catalogues of specifications are followed, a belt life of 3 million reverse bending cycles occurring over 10 years can be expected. This value was measured in tests under laboratory conditions.

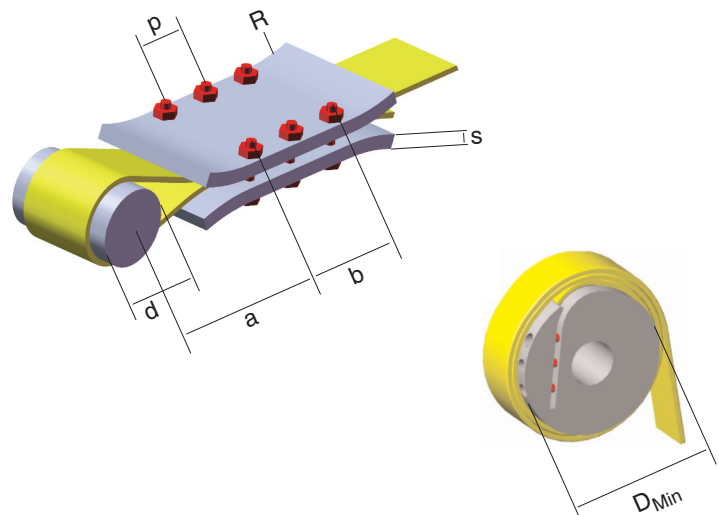

F1



Belt characteristics

- Polyurethane flat belt with steel tension cords
- It is mainly used in lifting applications where there is no need for synchronization
- Allows the use of small diameter pulleys and compact drive design
- Black colour as standard
- Maintenance free
- Reduced thickness tolerance available on request

- Width tolerance: $\pm 0,5$ [mm]
- Thickness tolerance: $\pm 0,2$ [mm]

Technical Data

Belt width b [mm]	Allowable tensile load Type M F_{Tzul} [N]	Allowable tensile load Type V F_{Tzul} [N]	Breaking load Type M F_{Br} [N]	Specific spring rate C_{spez} [N]	Weight [kg/m]
10	320	160	1250	80000	0,02
20	700	350	2750	175000	0,04
30	1090	545	4250	272500	0,05
40	1470	735	5750	367500	0,08
50	1860	930	7250	465000	0,09
100	3780	1890	14750	945000	0,21

Load / Elongation [%]

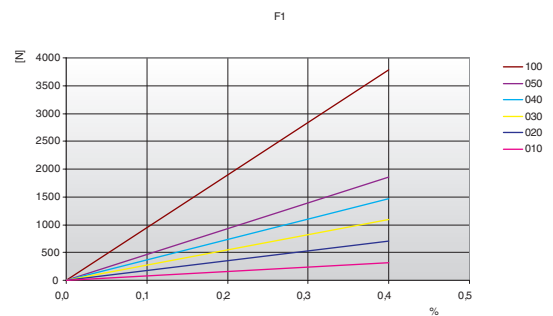

Other widths are available on request.

Minimum pulley diameter	Drive without reverse bending [mm]	Drive with reverse bending [mm]
	16	30

Specialties

Belt width b [mm]	ARAMID CORD	
	F_{Tzul} [N] M type	F_{Br} [N]
10	700	2800
20	1540	6160
30	2380	9520
40	3220	12880
50	4060	16240
100	8260	33040

F2



Belt characteristics

- Polyurethane flat belt with steel tension cords
- It is mainly used in lifting application where there is no need for synchronization
- Allows the use of small diameter pulleys
- Black colour as standard
- Maintenance free
- Reduced thickness tolerance available on request

• Width tolerance: $\pm 0,5$ [mm]
 • Thickness tolerance: $\pm 0,2$ [mm]

Technical Data

Belt width b [mm]	Allowable tensile load Type M F _{Tzul} [N]	Allowable tensile load Type V F _{Tzul} [N]	Breaking load Type M F _{Br} [N]	Specific spring rate C _{spez} [N]	Weight [kg/m]
10	1470	735	5700	367500	0,03
15	2210	1105	8550	552500	0,05
25	4170	2085	16150	1042500	0,08
30	4660	2330	18050	1165000	0,10
50	8580	4290	33250	2145000	0,17
75	12990	6495	50350	3247500	0,25
100	17400	8700	67450	4350000	0,34

Load / Elongation [%]

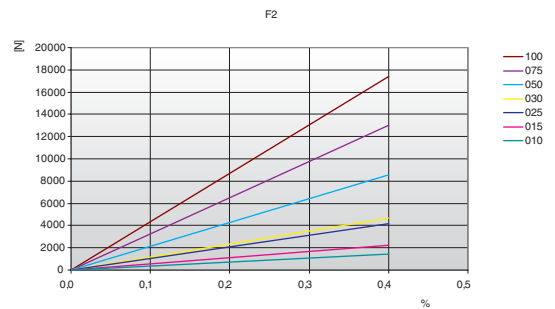

Other widths are available on request.

Minimum pulley diameter	Drive without reverse bending [mm]	Drive with reverse bending [mm]
	50	100

Specialties

Belt width b [mm]	ARAMID CORD		STAINLESS STEEL	
	F _{Tzul} [N] M type	F _{Br} [N]	F _{Tzul} [N] M type	F _{Br} [N]
10	1320	6000	1080	4500
15	1980	9000	1620	6750
25	3740	17000	3060	12750
30	4180	19000	3420	14250
50	7700	35000	6300	26250
75	11660	53000	9540	39750
100	15620	71000	12780	53250

F2,5



- Width tolerance: $\pm 0,5$ [mm]
- Thickness tolerance: $\pm 0,2$ [mm]

Belt characteristics

- Polyurethane flat belt with steel tension cords
- It is mainly used in lifting application where there is no need for synchronization
- Allows the use of small diameter pulleys
- Black colour as standard
- Maintenance free
- Reduced thickness tolerance available on request

Technical Data

Belt width b [mm]	Allowable tensile load Type M F_{Tzul} [N]	Allowable tensile load Type V F_{Tzul} [N]	Breaking load Type M F_{Br} [N]	Specific spring rate C_{spez} [N]	Weight [kg/m]
20	5280	2640	19250	1320000	0,08
25	6720	3360	24500	1680000	0,09
50	14400	7200	52500	3600000	0,18
75	21600	10800	78750	5400000	0,27
100	29280	14640	106750	7320000	0,36
120	35040	17520	127750	8760000	0,42

Other widths are available on request.

Load / Elongation [%]

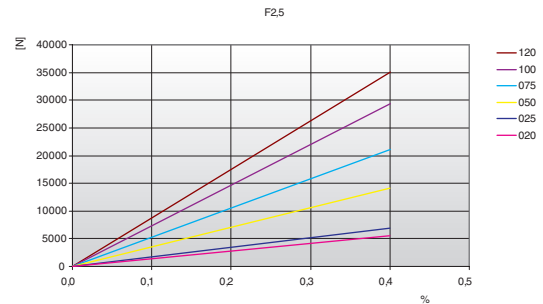

Minimum pulley diameter	Drive without reverse bending [mm]	Drive with reverse bending [mm]
	80	150

F3



- Width tolerance: $\pm 0,5$ [mm]
- Thickness tolerance: $\pm 0,2$ [mm]

Belt characteristics

- Polyurethane flat belt with steel tension cords
- It is mainly used in lifting application where there is no need for synchronization
- Allows the use of small diameter pulleys
- Black colour as standard
- Maintenance free
- Reduced thickness tolerance available on request

Technical Data

Belt width b [mm]	Allowable tensile load Type M F_{Tzul} [N]	Allowable tensile load Type V F_{Tzul} [N]	Breaking load Type M F_{Br} [N]	Specific spring rate C_{spez} [N]	Weight [kg/m]
25	8500	3400	32000	2125000	0,11
30	10200	5100	38400	2550000	0,12
60	21250	10625	80000	5312500	0,24
120	43350	21675	163200	10837500	0,48
150	53550	201600	267750	13387500	0,60

Other widths are available on request.

Load / Elongation [%]

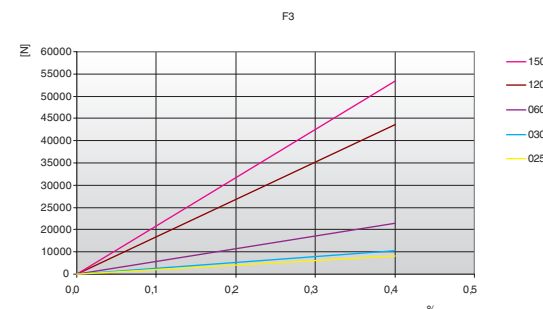

Minimum pulley diameter	Drive without reverse bending [mm]	Drive with reverse bending [mm]
	120	180

FLAT Heavy Series

ELATECH® FLAT belt heavy series has been developed for the need in the automotive industry. They are used to lift car bodies in production lines or to convey car bodies or finished cars (skid supporting belt). They are made with 85 Sh A polyurethane body to ensure high grip on the motor pulley and with high performance steel tension member.

F9



Belt characteristics

- Polyurethane flat belt with steel tension cords
- Long service life
- Black colour as standard
- Maintenance free
- Minimum elastic elongation
- No cords exposed

F9 - Technical Data

- Width tolerance: $\pm 1,0$ [mm]
- Thickness tolerance: $\pm 0,5$ [mm]

Belt width b [mm]	Allowable tensile load Type M F_{Tzul} [N]	Breaking load Type M F_{Br} [N]	Specific spring rate C_{spez} [N]	Weight [kg/m]
75	34000	119000	8500000	1,1
90	42000	147000	10500000	1,6
105	50000	175000	12500000	1,6
125	60000	210000	15000000	1,9
180	88000	308000	22000000	2,8

Other widths are available on request.

Load / Elongation [%]

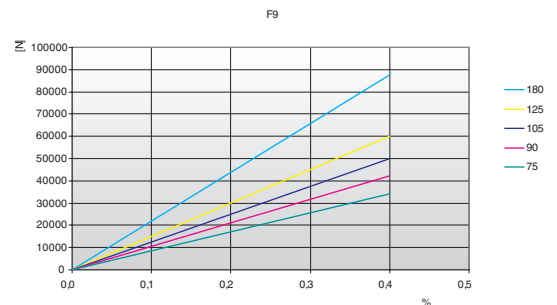

Minimum pulley diameter	Drive without reverse bending [mm]	Drive with reverse bending [mm]
	200	300

POLY-V K

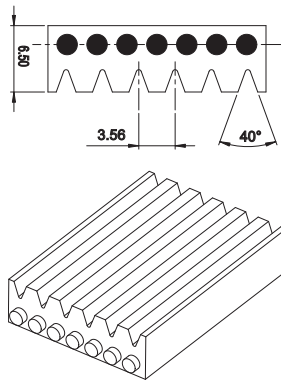

Belt characteristics

- Polyurethane Poly-V belt with K profile and high tensile load steel cords for high performance and increased flexibility
- The Poly-V profile allows torque high transmission, small pulley diameter
- Low noise generation
- Widely used in lifting applications
- Special cords available on request

- Width tolerance: $\pm 1,0$ [mm]
- Thickness tolerance: $\pm 0,4$ [mm]

Technical Data

Belt width b [mm]	Allowable tensile load Type M F_{Tzul} [N]	Breaking load Type M F_{Br} [N]	Specific spring rate C_{spez} [N]	Weight [kg/m]
25	7700	31500	1925000	0,35
30	17600	72000	4400000	0,70
75	27500	112500	6875000	1,10
100	35200	144000	8800000	1,45
150	55000	225000	13750000	2,20

Other widths are available on request.

Minimum pulley diameter	Drive without reverse bending [mm]	Drive with reverse bending [mm]
	150	250

Load / Elongation [%]

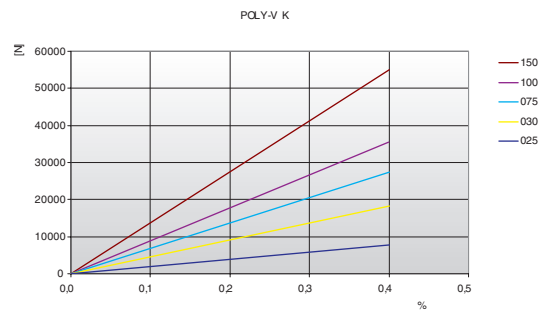

TT5

TT5 Polyurethane timing belts

ELATECH® manufactures special TT5 belts which have been expressly designed for application in circular knitting machines drives.

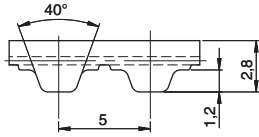

Belt characteristics

- Trapezoidal tooth profile according to DIN 7721 T1
- Metric pitch 5 mm
- Standard colour: blue with kevlar cords, white with steel cords, other colours available on request
- Polyurethane 88 Sh A

- Width tolerance: ±0,5 [mm]
- Length tolerance: ±0,5 [mm/m]
- Thickness tolerance: ±0,2 [mm]

Technical Data

ELATECH® belts TT5 are available in the following executions:

ELATECH® - V

- A special splicing and welding process offers superior traction load resistance
- They are available both with steel and aramid cords
- Special colours available on demand
- Available in any length tooth by tooth

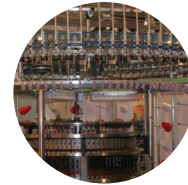

ELA-flex SD™ truly endless

- ELA-flex SD™ TT5 have no splice and welding and therefore offer best traction resistance load
- They are available both with steel and aramid cords
- Special colours available on demand
- Available in all lengths tooth by tooth up to a length of 13500 mm

Belt width b [mm]	Allowable tensile load Type M F _{Tzul} [N]	Allowable tensile load Type V F _{Tzul} [N]	Breaking load Type M F _{Br} [N]	Weight [kg/m]
ARAMID (Kevlar) cords				
10	840	420	3360	0,019
STEEL cords				
10	320	190	1250	0,021

Type	Belt length [mm]	Type	Belt length [mm]
10TT5/4800K	4800	10TT5/9200K	9200
10TT5/5000K	5000	10TT5/9400K	9400
10TT5/5200K	5200	10TT5/9600K	9600
10TT5/5600K	5600	10TT5/9800K	9800
10TT5/5800K	5800	10TT5/10000K	10000
10TT5/6000K	6000	10TT5/10200K	10200
10TT5/6200K	6200	10TT5/10300K	10300
10TT5/6400K	6400	10TT5/10400K	10400
10TT5/6600K	6600	10TT5/10600K	10600
10TT5/6800K	6800	10TT5/10800K	10800
10TT5/7000K	7000	10TT5/11200K	11200
10TT5/7200K	7200	10TT5/11300K	11300
10TT5/7400K	7400	10TT5/11800K	11800
10TT5/7500K	7500	10TT5/12000K	12000
10TT5/7600K	7600	10TT5/12300K	12300
10TT5/7800K	7800	10TT5/12700K	12700
10TT5/8000K	8000	10TT5/12800K	12800
10TT5/8200K	8200	10TT5/13000K	13000
10TT5/8300K	8300	10TT5/13200K	13200
10TT5/8400K	8400	10TT5/13400K	13400
10TT5/8600K	8600	10TT5/13600K	13600
10TT5/8800K	8800	10TT5/15400K	15400
10TT5/8900K	8900	10TT5/17900K	17900
10TT5/9000K	9000		

Flexibility

Minimum pulley number of teeth and minimum idler diameter		Type of cord	
		STANDARD	ARAMID
	Timing pulley z _{min}	12	12
	Flat idler running on belt teeth d _{min}	30 mm	30 mm
	Timing pulley z _{min}	15	15
	Flat idler running on belt back d _{min}	30 mm	30 mm

Note: Steel tensile cord member available upon request

ELATECH® SYNCRO-MAX® Extra-wide

ELATECH® SYNCRO-MAX® Extra-wide Polyurethane Belts extend the advantages of synchronous timing belts to wider surfaces and to the typical applications of flat and modular conveyor belts.

Made of Polyurethane and reinforced with Aramid, ELATECH® SYNCRO-MAX® Extra-wide Belts provide positive drive and synchronous conveying resulting in no slippage, better tracking, higher indexing/positioning precision, smaller drive pulley requirements, lower belt tension, lower shaft loads and consequently power saving.

Open or jointed, coated with Silicon, Rubber, PU or PVC backings, perforated or grooved with complex design, and equipped with a wide range of tracking guides and profiles of different shapes and dimensions, ELATECH® SYNCRO-MAX® Extra-wide Belts offer the best solution for a great number of applications such as the production of baby diapers and feminine hygiene products and the production of tires as well as in many other industrial fields like food, tobacco, metal, wood, glass, and of course conveying and packaging.

Product overview

- Natural colour PU compound material
- High durability
- Cut resistant
- Grease, chemicals and water resistant
- Non-marking
- Kevlar (Aramid) parallel cord reinforcement
- No cords exposure on belt edges
- Even cord tension

Available options

- FDA-compliant PU compound
- PAZ/PAR for noise reduction
- Tracking guides on teeth and/or on back
- Silicon, PU, PVC and rubber backings
- Wide range of cleats, flights and profiles
- Perforation by high precision water-jet cutting technology

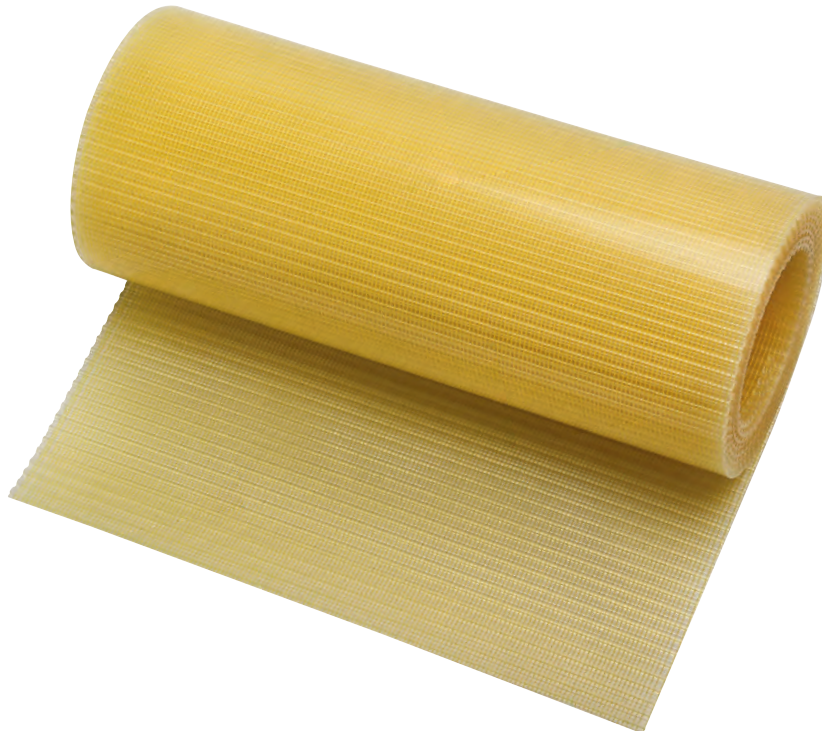

SYNCRO-MAX® W-T10

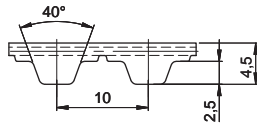
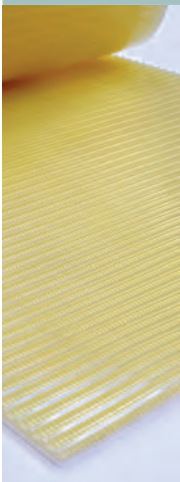

Belt characteristics

- Polyurethane timing belt with Aramid tension cords
- Tooth profile according to ISO 17396
- Metric pitch 10 mm
- Natural colour PU compound 92 Sh A
- Standard roll length = 50 m

- Width tolerance: $\pm 1,0$ [mm]
- Thickness tolerance: $\pm 0,3$ [mm]

Technical Data

Belt width b [mm]	Allowable tensile load Type M F_{Tzul} [N]	Allowable tensile load Type V F_{Tzul} [N]	Breaking load Type M F_{Br} [N]	Specific spring rate C_{spez} [N]	Weight [kg/m]
200	8140	4070	31159	1017500	0,76
250	10210	5105	39088	1276250	0,95
300	12280	6140	47016	1535000	1,14
350	14360	7180	54945	1795000	1,33
400	16430	8215	62874	2053750	1,52
450	18500	9250	70802	2312500	1,71
500 / 510	20570	10285	78731	2571250	1,90

Flexibility

Minimum pulley number of teeth and minimum idler diameter	Type of cord	
	ARAMID	
 Drive without reverse bending	Timing pulley z_{min}	15
	Flat idler running on belt teeth d_{min}	60 mm
 Drive with reverse bending	Timing pulley z_{min}	20
	Flat idler running on belt back d_{min}	60 mm

Other widths are available on request.

Tooth shear strength

rpm	F_{Uspez} [N/cm]	rpm	F_{Uspez} [N/cm]	rpm	F_{Uspez} [N/cm]	rpm	F_{Uspez} [N/cm]
0	51,80	800	33,34	1900	26,53	4500	19,40
20	50,32	900	32,44	2000	26,12	5000	18,51
40	49,04	1000	31,63	2200	25,34	5500	17,70
60	47,92	1100	30,89	2400	24,63	6000	16,97
80	46,95	1200	30,21	2600	23,97	6500	16,29
100	46,11	1300	29,58	2800	23,36	7000	15,66
200	42,75	1400	28,99	3000	22,78	7500	15,07
300	40,28	1440	28,76	3200	22,25	8000	14,52
400	38,36	1500	28,44	3400	21,74	8500	14,00
500	36,80	1600	27,92	3600	21,27	9000	13,51
600	35,49	1700	27,43	3800	20,81	9500	13,05
700	34,35	1800	26,97	4000	20,39	10000	12,61

Tooth shear strength / rpm

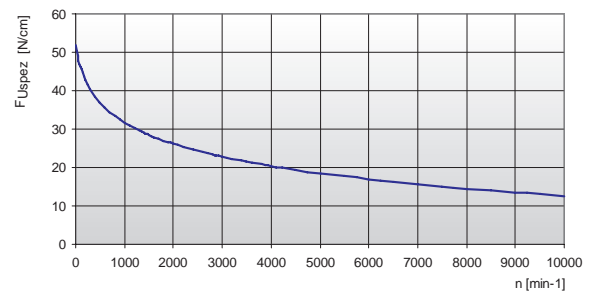

The specific load F_{Uspez} is the maximum load which one single belt tooth 1 cm wide can withstand in all operating conditions. This force is related to the drive rpm. The total load F_u transmissible by the belt in the drive is calculated by:

$$F_u \text{ [N]} = F_{Uspez} \cdot z_e \cdot b$$

Note: Ultimate tensile strengths are listed for reference purposes only. The values listed above are a theoretical calculation based on average cord strength and may not represent actual tensile test results.

- F_u [N] = peripheral force
- F_{Uspez} [N/cm] = specific load
- z_e = number of teeth in mesh in the small pulley
- z_{emax} = max. no of teeth in mesh to be considered for the calculation of the drive = 12 for ELATECH® M
- z_{emax} = 6 for ELATECH® V
- b [cm] = belt width in cm

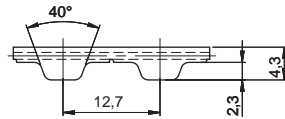
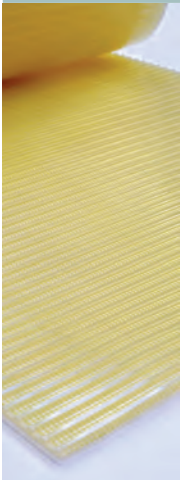
Belt characteristics

- Polyurethane timing belt with Aramid tension cord
- Tooth profile according to UNI/ISO 5296
- Imperial pitch 1/2" = 12,7 mm
- Natural colour PU compound 92 Sh A
- Standard roll length = 50 m

- Width tolerance: ±1,0 [mm]
- Thickness tolerance: ±0,3 [mm]

Technical Data

Belt width b Code / mm	Allowable tensile load Type M F _{Tzul} [N]	Allowable tensile load Type V F _{Tzul} [N]	Breaking load Type M F _{Br} [N]	Specific spring rate C _{spez} [N]	Weight [kg/m]
8 / 203,2	8140	4070	31159	1017500	0,70
10 / 254	10210	5105	39088	1276250	0,90
12 / 304,8	12280	6140	47016	1535000	1,05
14 / 355,6	14360	7180	54945	1795000	1,24
16 / 406,4	16430	8215	62874	2053750	1,42
18 / 457,2	18500	9250	70802	2312500	1,60
20 / 508	20570	10285	78731	2571250	1,80

Flexibility

Minimum pulley number of teeth and minimum idler diameter	Type of cord	
	ARAMID	
 Drive without reverse bending	Timing pulley z _{min}	14
	Flat idler running on belt teeth d _{min}	60 mm
 Drive with reverse bending	Timing pulley z _{min}	20
	Flat idler running on belt back d _{min}	80 mm

Other widths are available on request.

Tooth shear strength

rpm	F _{Uspez} [N/cm]	rpm	F _{Uspez} [N/cm]	rpm	F _{Uspez} [N/cm]	rpm	F _{Uspez} [N/cm]
0	45,30	800	29,04	1900	23,11	4500	16,88
20	43,95	900	28,26	2000	22,74	5000	16,11
40	42,78	1000	27,55	2200	22,07	5500	15,41
60	41,77	1100	26,90	2400	21,44	6000	14,76
80	40,88	1200	26,31	2600	20,87	6500	14,17
100	40,11	1300	25,76	2800	20,34	7000	13,62
200	37,22	1400	25,25	3000	19,84	7500	13,11
300	35,07	1440	25,05	3200	19,37	8000	12,63
400	33,41	1500	24,77	3400	18,93	8500	12,18
500	32,05	1600	24,32	3600	18,51	9000	11,75
600	30,90	1700	23,89	3800	18,12	9500	11,35
700	29,91	1800	23,49	4000	17,75	10000	10,96

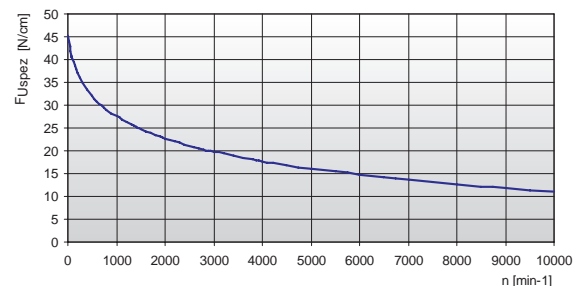
Tooth shear strength / rpm

The specific load F_{Uspez} is the maximum load which one single belt tooth 1 cm wide can withstand in all operating conditions. This force is related to the drive rpm. The total load F_u transmissible by the belt in the drive is calculated by:

$$F_u [N] = F_{Uspez} \cdot z_e \cdot b$$

Note: Ultimate tensile strengths are listed for reference purposes only. The values listed above are a theoretical calculation based on average cord strength and may not represent actual tensile test results.

- F_u [N] = peripheral force
- F_{Uspez} [N/cm] = specific load
- z_e = number of teeth in mesh in the small pulley
- z_{emax} = max. no of teeth in mesh to be considered for the calculation of the drive
- z_{emax} = 12 for ELATECH® M
- z_{emax} = 6 for ELATECH® V
- b [cm] = belt width in cm